Subfossil mammalian tracks (Flandrian) in the Severn Estuary, S. W. Britain: mechanics of formation, preservation and distribution

J. R. L. Allen

Phil. Trans. R. Soc. Lond. B 1997 **352**, 481-518

doi: 10.1098/rstb.1997.0035

References

Article cited in:

<http://rstb.royalsocietypublishing.org/content/352/1352/481#related-urls>

Email alerting service

Receive free email alerts when new articles cite this article - sign up in the box at the top right-hand corner of the article or click [here](#)

To subscribe to *Phil. Trans. R. Soc. Lond. B* go to: <http://rstb.royalsocietypublishing.org/subscriptions>

Subfossil mammalian tracks (Flandrian) in the Severn Estuary, S.W. Britain: mechanics of formation, preservation and distribution

J. R. L. ALLEN

Postgraduate Research Institute for Sedimentology, The University of Reading, P.O. Box 227, Whiteknights, Reading RG6 6AB, UK

CONTENTS

	PAGE
1. Introduction	482
2. Terminology	483
3. A model of track formation	485
(<i>a</i>) Limbs as indenters	485
(<i>b</i>) Sediments as elastic-plastic solids	485
(<i>c</i>) Elastic region	486
(<i>d</i>) Plastic region: general	486
(<i>e</i>) Semi-infinite plastic region	487
(<i>f</i>) Finite plastic region	487
(<i>g</i>) Conclusion	488
4. Laboratory experiments on track-making	488
(<i>a</i>) Materials and methods	488
(<i>b</i>) Mode and intensity of deformation	491
(<i>c</i>) Geometry of deformation	493
(<i>d</i>) Features due to a slot	496
(<i>e</i>) Conclusion	497
5. Track-making in the contemporary sediments	497
(<i>a</i>) Tidal and climatic regimes	497
(<i>b</i>) Sedimentological background	497
(<i>c</i>) Larger mammalian inhabitants	498
(<i>d</i>) Tracks in semi-liquid mud	498
(<i>e</i>) Tracks in soft mud	500
(<i>f</i>) Tracks in stiff mud	500
(<i>g</i>) Tracks in firm and hard mud	500
(<i>h</i>) Trampled surfaces	500
(<i>i</i>) Contemporaneity of tracks with sedimentation	501
6. Distribution and preservation of sub-fossil tracks	501
(<i>a</i>) Review of late Quaternary stratigraphy	501
(<i>b</i>) Mammalian fauna	502
(<i>c</i>) Lower Wentlooge Formation	503
(<i>d</i>) Middle Wentlooge Formation	505
(<i>e</i>) Upper Wentlooge Formation	505
(<i>f</i>) Rumney Formation	505
(<i>g</i>) Awre Formation	508
(<i>h</i>) Northwick Formation	508
7. Discussion	511
8. Conclusions	514
References	514

SUMMARY

Mammalian tracks and trackways are widely preserved at all stratigraphical levels in the Flandrian sediments of tidal mudflat and marsh origins which formed over the last 8000–9000 years on the marginal wetlands of the inner Bristol Channel and Severn Estuary. The fauna recorded in this way, however, is less diverse than that known from the few, small assemblages of skeletal remains, including some from

archaeological sites, so far assessed. Missing or rarely represented in terms of tracks are the smaller of the large mammals. Humans are represented by tracks throughout the Flandrian deposits. In the earlier Flandrian, they were accompanied by deer and aurochs which gave way, in the later Flandrian, to domesticated cattle and sheep/goat; there are sporadic indications of the presence of horse. Wolf/dog, represented by just two records, is the only smaller large mammal so far recorded as a track.

The tracks were made, modified, and eventually preserved under a wide variety of sedimentological conditions on the margins of the estuary. Those environmental conditions constrained the quality of the anatomical evidence preserved in the tracks but can be inferred from the character of the tracks. Field experiments suggest that the moisture content of the sediment at the time was crucial to the general nature of the tracks. The mudflat-marsh silts which received the tracks varied from semi-liquid to firm, depending on tidal and seasonal factors and on the elevation of the sedimentary surface relative to the tidal frame. Some tracks were made in marsh peats which offered little resistance. Deep tracks preserving little detail were produced in weak sediments of high moisture content; tracks formed in strong, firm muds retained full anatomical detail. Referring to mechanical theory, and to a series of laboratory experiments using Plasticine, the act of making a track is shown to be similar in character and effect to the indentation of an ideal elastic-plastic material by a punch. The punch represents the descending limb of the animal, the face of the punch the sole of the animal's foot, and the elastic-plastic material the sediment which is pierced and deformed by the downward action of the limb. The character of the experimental tracks, and the range and relative size of the deformation structures they include, is qualitatively similar to what is recorded from the field. Many of the tracks recorded from the field were variously modified in a changeable and dynamic environment before final burial and preservation.

1. INTRODUCTION

When a vertebrate animal progresses over a surface of sufficiently soft sediment, it leaves behind a series of traces or *tracks*, which collectively form a *trackway*. In principle, as every hunter has known, the character of these spoor reveals the taxonomic position and age of the animal, its direction of travel, its gait and speed, and its health and behaviour at the time. From the sediment which received the impressions, even when fossilized, may be deduced the character of the environment through which the animal was moving, adding a further dimension to an appreciation of the ecological position of the organism. Indeed, tracks and trackways, with their high preservation potential as trace fossils in sediments, may in many instances be more revealing about the composition, abundance and environmental range of past vertebrate faunas and their ways of life than skeletal material (body fossils), so readily subject to scavenging, dispersal, and decay either before or after burial in sediment. Early work stressed the taxonomic significance of tracks and trackways, but a strong appreciation of their ecological value has been added in recent years.

Fossil reptile and dinosaur tracks attracted early attention (e.g. Hitchcock 1858) and are the subject of a huge literature (Sarjeant 1974, 1975, 1987; Delair & Sarjeant 1985) and important recent syntheses that stress their ecological value (Gillette 1986; Lockley 1986, 1991*a, b*; Leonardi 1987; Gillette & Lockley 1989; Thulborn 1990; Lockley *et al.* 1994; Lockley & Hunt 1995). Tracks of mammalian origin, predominant in Tertiary and Quaternary sediments, have attracted less attention but are being increasingly reported from a widening range of geological (Robertson & Sternberg 1942; Chaffee 1943; Bjork 1976; Demathieu *et al.* 1984; Loope 1986; Scrivner & Bottjer 1986; Leakey 1987; Belperio & Fotheringham 1990; Loope & Simpson 1992; Smith *et al.* 1993; Lea

1996; Roberts *et al.* 1996) and archaeological (Michel 1968; Fowler *et al.* 1976; Cramm & Fulford 1979; Smith *et al.* 1981; Bahn & Vertut 1988) settings. Scrivner & Bottjer (1986) give a substantial listing of papers. Hominid and human footprints have long been known from cave sites (e.g. Vallois 1931; Clottes & Simonnet 1972, 1984; Bégouer & Clottes 1984; Faton & Richet 1985). They are also reported, in some instances as lengthy trackways, from a range of terrestrial (Brown 1947; Haberland & Grebe 1955; Leakey & Hay 1979; Day & Wickens 1980; Behrensmeier & Laporte 1981; Leakey *et al.* 1987) and coastal (Mountain 1966; Belperio & Fotheringham 1990; Aldhouse-Green *et al.* 1992; Politis & Bayon 1995; Price 1995; Roberts *et al.* 1996) deposits. Preservation is especially good in damp volcanic ash and in stiff-firm, laminated, intertidal muds.

An understanding of the mechanics of track-making and the taphonomy of the traces continues greatly to lag behind knowledge of the anatomical aspects and distribution of tracks, despite the importance of these questions to secure taxonomic and ecological interpretations. So far, two main approaches have been adopted. Several workers made observations or experiments using live animals allowed to wander over selected natural or prepared substrates (e.g. Brown 1911; McKee 1947; Peabody 1959; Reineck & Howard 1978; Brand 1979; Fichter 1982, 1983; Padian & Olsen 1984). Allen (1989) proposed that the limb and foot of an animal making a track could be regarded as a punch or indenter, and described some preliminary results from laboratory experiments in which an artificial limb and foot was allowed to deform a prepared mass of Plasticine. Other investigators collected evidence of tracks and track associations in contemporary environments, from aeolian dunes (Lewis & Titheridge 1978; Fryberger *et al.* 1983), barrier coasts (Van der Lingen & Andrews 1969; Frey & Pemberton 1986, 1987), a lake delta (Frostick &

Reid 1986), and a lake-shore (Cohen *et al.* 1991, 1993). However, several important environments remain unrepresented in this list, and none can yet be described as well-characterized, in terms of an acceptable number of globally representative examples.

The aims of this paper are to provide an introductory account of the formation, taphonomy and distribution of contemporary and sub-fossil (Flandrian) mammalian tracks in a large estuarine environment (the Severn Estuary) in which salt marshes and tidal mudflats abound, and to support the field observations on formation with simple laboratory experiments related to a theoretical mechanical model. The substantial outcrops of Flandrian sediment, and the modern salt marshes and high intertidal mudflats, have been walked as thoroughly as possible, in the case of the former particularly from autumn to spring, when wave action ensures that the exposures are least obscured by mobile sand and mud. Extensive exposed bedding surfaces afford the best opportunities for observing tracks in the silts and peats deposited on the ancient mudflats and salt marshes of the estuarine margins. The field procedures routinely applied were direct observation and measurement, photographic recording, and the dissection of selected tracks using a trowel or large kitchen knife. In the inner estuary, however, where the estuarine muds are well-laminated and comparatively sandy, tracks could also be freely sectioned (serially in some cases) and preserved as relief casts (peels) using solutions of cellulose acetate in acetone applied to cheesecloth stretched over the prepared traces (Bouma 1969). In a study of human trackways (Aldhouse-Green *et al.* 1992), successful use was made of X-radiographs of thin slices cut serially using a cheese-wire from an excavated block of sediment that contained a track.

2. TERMINOLOGY

Mammalian tracks are included within the category of trace fossils (also called ichnofossils or *Lebenspuren*), for they are marks preserved in sediment which record the activities of organisms. Two nomenclatures are required in order to describe tracks and trackways. One relates to the surviving evidence for particular anatomical features and, therefore, is track-specific. The other is more general and aims to cover the many features displayed by tracks as marks resulting from the deformation of sediments by organisms. Figure 1 summarizes a descriptive nomenclature of the latter kind which expands on an earlier, preliminary scheme (Allen 1989).

As each limb of a moving animal in turn descends to meet and penetrate the surface of the sediment, the foot cuts a more or less deep and vertical *shaft* into the deformable substrate (figure 1*a*). Depending on the consistency of the sediment, the shaft may vary from a shallow imprint, with a depth only a tiny fraction of the width, to a pit deeper than wide (e.g. Laury 1980; Frey & Pemberton 1986; Lockley *et al.* 1986; Scrivner & Bottjer 1986; Smith 1993; Scarboro & Tucker 1995). In cross-section, the shaft may vary from essentially circular over the whole of its depth to

increasingly elongated upward, depending on the extent to which the limb hinges about the foot once the latter has reached its terminal position. Roughnesses on the edge of the foot as it either cuts or leaves the sediment may impart steeply inclined *striae* to the surface of the shaft, especially toward the *lip* (e.g. Lockley *et al.* 1989). At the bottom of the shaft lies the *footprint*, a more or less faithful mould of the sole of the foot in the sediment last in contact with the foot. Only under limited circumstances are footprints in this strict sense ever seen.

The descent of the foot deforms the sediment in a wide variety of ways, creating a substantial *deformed zone* which embraces the whole of the shaft (figure 1*a*). The deformation structures include folds of various scales, suggesting that the sediment responded in a viscous-plastic manner, and faults, pointing to a brittle response. A *marginal ridge* following the outline of the foot is commonly formed on the surface of the sediment (e.g. Tucker & Burchette 1977; Demathieu *et al.* 1984; Hay & Leakey 1987; Leakey 1987; Leakey *et al.* 1987; Belperio & Fotheringham 1990). A corresponding, encircling, *marginal upfold* is developed beneath the surface ridge (e.g. Ginsburg *et al.* 1966; Laury 1980; Allen 1989; Smith 1993). Surface *radial fractures* have been reported to accompany a ridge and upfold (Scrivner & Bottjer 1986; Lockley *et al.* 1989). In damp sands, one or more outward *marginal thrusts* may either accompany or replace the marginal fold (e.g. Frey & Pemberton 1986; Leonardi & Sarjeant 1986; McKeever 1991, 1994). Laminae in the sediment beneath the footprint may be bent downward into a more or less deep, basin-like, *axial downfold* (e.g. Loope 1986; Allen 1989; Smith *et al.* 1993; Lea 1996), associated with *microfaults* of various kinds and *microfolds* (Aldhouse-Green *et al.* 1992; Nadon 1993). Microfaults that are curved in the horizontal plane may appear to the sides of the shaft, but are most commonly seen dipping down toward the axis of the shaft beneath the footprint. Swinehart (1990) records an exceptionally fine example of the latter beneath a (?) bison footprint in wind-blown sand. According to Maltman (1988), the presence of shear zones in the (muddy) sediment denotes a moisture content of less than 60–70%. Since the deformational regime in the floor of the downfold is essentially one of layer-normal compression, the microfolds may be expected to have affinities with Kidan & Cosgrove's (1996) 'pinch-and-swell' structures. Some of the radial fractures described by Lockley *et al.* (1989) have the appearance of being radiating microfolds. The surfaces of laminae within the axial downfold will also display what have been variously called *Innenspur* (Seilacher 1953), *sous-traces* (Heyler & Lessertisseur 1963), undertracks (Goldring & Seilacher 1971), *undertraces* (Allen 1989) or transmitted prints (Smith 1993). Hitchcock (1858, p. 32, Pl. VI.1), in his early study, was well aware of the occurrence and significance of undertracks, and was quick to point out that the quality of preservation of anatomical detail rapidly weakened downward within a stack.

Other markings in addition to the marginal ridge may be seen on the sediment surface (figure 1*b, c*).

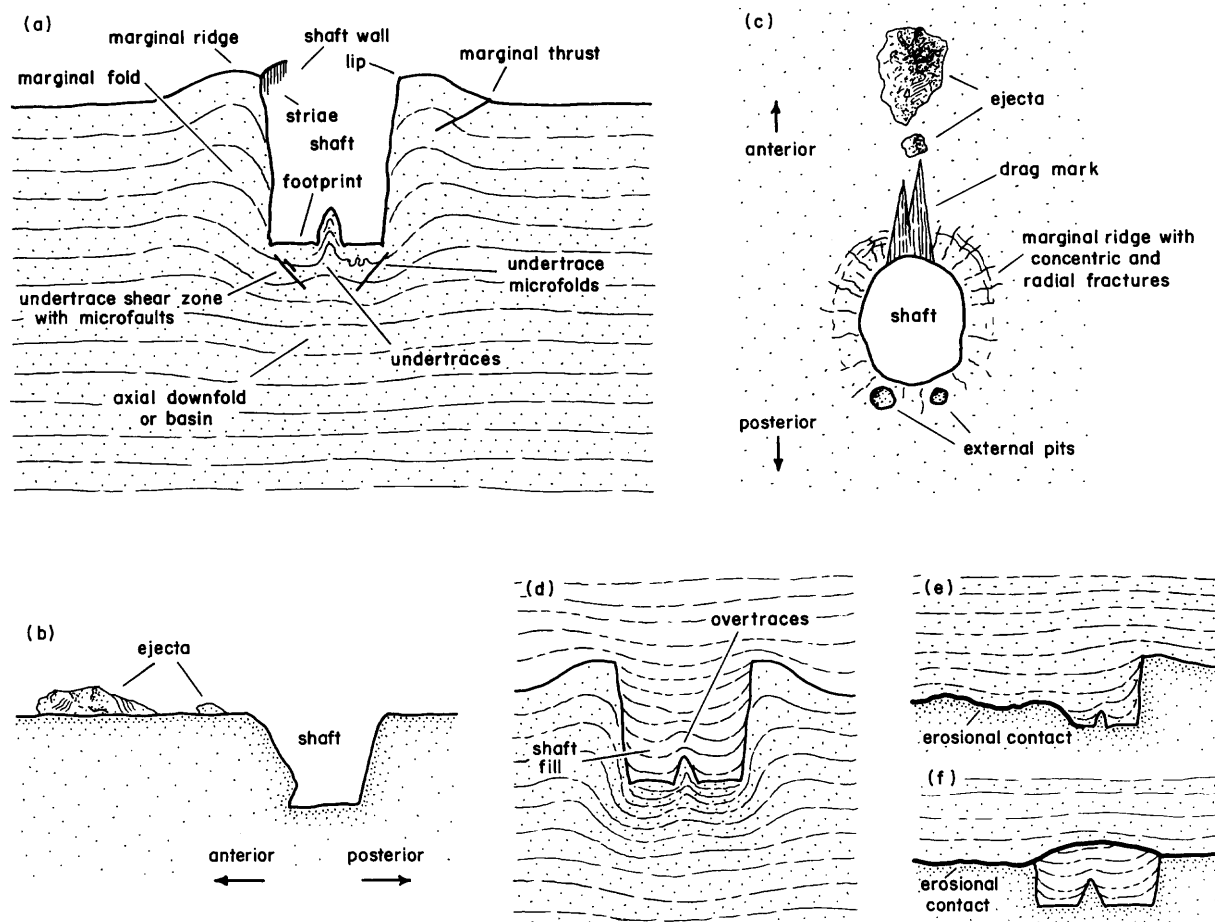

Figure 1. Schematic general morphology of mammalian tracks. (a) The track of a two-toed animal in transverse vertical section. (b) A track in longitudinal vertical section. (c) A track as seen from above on the sedimentary surface. (d) The preserved track of a two-toed animal in transverse vertical section. (e, f) Various erosional modifications of tracks in the course of preservation.

When travelling over soft-stiff mud, animals with more than one toe commonly eject through the interdigital clefts, often violently, small amounts of sediment on to the surface ahead or to the side; at the same time, the toes become increasingly separated, splaying outward. These *ejecta* vary from dispersed splatters to one or two more substantial striated lumps, depending on the consistency of the sediment. The toes or claws of the animal, as each foot either descends into or is retracted from the sediment, occasionally make short, striated *drag marks* or scrapes at the posterior (trailing)/anterior (leading) edge of a track (e.g. Smith 1993). Related to these are long *skim marks*, created on the surface usually by part of the bent foot before a descent into deep mud (e.g. Leakey 1987), and *skid marks* (Stuart 1982), formed when the whole foot slips in a soft but thin layer, before engaging with and descending into firmer sediment below. In some instances, the marginal ridge is associated with patterns of *radial* and *concentric fractures* which penetrate for some distance into the fold beneath (e.g. Scrivner & Bottjer 1986; Lockley *et al.* 1989; Nadon 1993). The radial ones typically are vertically oriented, but the concentric features normally resemble outward thrusts. In two-toed animals, digits/accessory digits II and IV are raised off the

ground and either a little smaller than digits III and IV, as in the suids (Barone 1976), or reduced to a pair of tiny digits and hooves (dewclaws), as in cervids and bovids (Ashdown & Done 1984). Pairs of symmetrically placed *external pits* recording these reduced digits are commonly associated posteriorly with the deeper shafts made by such animals (e.g. Gonzalez *et al.* 1996), those due to pigs being further to the side than in the case of cattle, sheep and goats.

The features named above all form during the descent of the foot into the substrate and its immediate withdrawal. There are other features which arise after the production of the track and during its burial, which may involve more than one accretionary or erosional event, as well as other processes. Figure 1d shows some of the features of tracks whose formation was completed as the result of a single depositional event, without intervening erosion. A *shaft fill* becomes emplaced in the space vacated by the foot. The infilling sediment may vary from laminated to structureless or, if material collapses from higher in the shaft, disrupted. As Hitchcock (1858) was early to appreciate, a series of upward-weakening *overtraces* will form in the shaft when sedimentary conditions permit a laminated plug to build up. These overtraces will preserve anatomical

details present on the footprint only where they immediately overlie it; in terms of quality of preservation, overtraces are the mirror images of undertraces (figure 1*d*). Where an erosional event followed the production of the shaft, but before it was infilled, a laterally inextensive, *erosional surface* may arise, obliterating part of the shaft and marginal fold (figure 1*e*). Where scouring followed the partial or complete infilling of the shaft, a widespread erosional surface will be present above a truncated deformed zone and shaft fill (figure 1*f*). Depending on the relative resistance to erosion of the sediments involved, the truncated *plug* may survive on the scoured surface in either negative or positive relief. Rarely, the plug is preserved as the capping to a mushroom-like pinnacle of less resistant sediment, rather as snow compressed beneath a footprint is preserved during a thaw.

Erosion exposes the fossil tracks preserved in sediments in various views. Vertical sections are of three main kinds: *axial* when they contain the axis or axial plane of the shaft or finely cut the axial plane, *internal-vertical* when they lie off the axis or axial plane but within the bounds of the shaft, and *external-vertical* when they are limited to the deformed zone outside the shaft. Sections more or less normal to the axis or axial plane are *transverse*. They may cut the track either above or below the level of the footprint, revealing either (a) the shaft with a fill of overtraces, (b) the shaft with a structureless fill, or (c) undertraces. *Oblique* sections are intermediate in orientation between the axial and transverse kinds.

3. A MODEL OF TRACK FORMATION

(a) *Limbs as indenters*

To make a track, the combined limb and foot of an animal must cut or otherwise permanently deform the sediment as it descends and is then withdrawn. The simplest mechanical model by which to understand the first stage in the process of track-making is provided by the action of an engineer's punch or indenter (Allen 1989), which is held perpendicular to the surface of a piece of metal or other substance and then pushed axially some way into it by an appropriate force, as in the Brinell and other hardness tests (Bishop *et al.* 1945; Rollason 1973; Hill *et al.* 1989). Ideally, the indenter should be much stronger and more rigid than the material under test, but it may have any of a wide range of shapes, for example, the flat head of a right-circular cylinder, a sphere, or a symmetrical wedge.

Some differences may be noted between a limb and foot and an indenter, and the action of each. For an indenter to be effective, it must deform negligibly as it is forced into the affected material, whereas the feet of animals are neither rigid nor inflexible; even in the case of hooved mammals (except horses), the toes are capable of a degree of relative movement when plunged into sediment (see above). Soft tissues supported by jointed phalanges, as in humans, will tend to mould themselves closely to the sediment they deform. The action of the force exerted through an indenter is always perpendicular to the surface of the affected

material; it is sudden and impulsive in the case of a struck punch, but is often chosen to be slow in hardness tests. The force exerted through a limb is applied gradually and over an interval measured in seconds during walking, but quickly and violently in running or galloping (Leutscher 1960; Bang & Dahlstrom 1974). It is always steeply inclined to the surface of the sediment, but usually describes a small angle as the limb hinges about the stationary foot between the descent and the withdrawal. In animals with limbs close to the plane of symmetry of the body, for example, humans and cattle, the angle is wholly contained in a parallel, vertical plane, and a slight forward followed by backward shear may be exerted on the sediment through the foot. The feet of reptiles with outward-pointing elbows and knees, however, lie distant from the plane of symmetry, and in these cases a tendency of the foot to exert a horizontal, rotational shear may also be apparent. These differences should be borne in mind when experimenting with or interpreting tracks, but they do not detract from the usefulness of the basic indenter/punch model.

(b) *Sediments as elastic-plastic solids*

The vast majority of recorded tracks are impressed into unconsolidated, polyphase sediments that range from clay-mineral or lime muds to siliciclastic or bioclastic-oid sands, and to laminated mixtures in between. In the voids of the mineral skeleton there was an interstitial fluid, varying from air alone, in a dry mud or sand, to water alone, in a fully saturated deposit, or to a mixture of water and air in the partially saturated state. Instead of air, bubbles of methane can arise in those watery sediments, especially muds, holding organic matter that continued to decay after deposition.

Many factors combine to confer 'strength' and other rheological properties upon these complex mixtures (Tertzaghi 1959; Parry 1972; Yong & Warkentin 1975). These properties, and the rate at which the animal's descending foot strained the sediment, combine to determine the amount and style of deformation observed in each track. The moisture content undoubtedly is crucial in all sediments at a time of track-making. For example, a given sand is generally stronger when partially saturated (damp), because of the action of surface-tension films, than when either fully saturated or dry. The contribution of surface tension is even more important in partially saturated muds, because of the very large number of films that can be held in the minute voids present in these deposits. Electrochemical and other non-frictional surface forces not only help to bind together the tiny grains that form saturated muds, but also ensure that these particles at the time of deposition assume very loose, open packings and only locally ordered fabrics, from within which pore water is expelled with difficulty. In the case of some muddy sediments, these same forces, controlling the disruption and reformation of fabrics during deformation, combine with other factors to introduce rate- and time-dependent rheological behaviour (e.g. shear-thinning, shear-stiffening, thixotropy). The

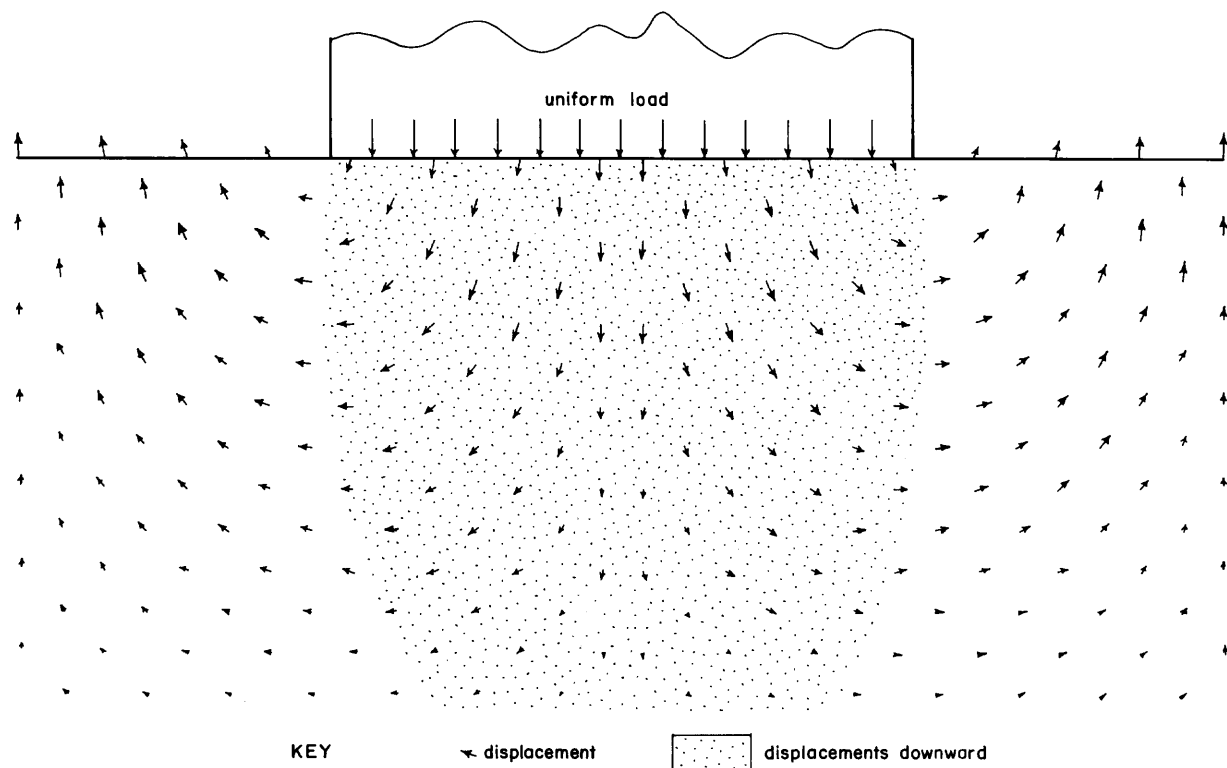

Figure 2. Relative calculated displacement vectors in an ideal elastic material under a strip load (adapted from Lambe & Whitman 1969, fig. 32.9).

strength of a sand also varies with the closeness of particle packing, and with the grain shape, surface roughness, and degree of preferred orientation in the aggregate as well. Some sands, either dry or wet, are deposited with such a loose, metastable grain packing that only a small force is needed to liquefy them temporarily (Allen 1982).

There is no single rheological model (Reiner 1969) that wholly satisfactorily describes the behaviour of unconsolidated sediments, which achieve such variety in terms of mineralogy, grain size and moisture content. The elastic-plastic model, however, is helpful under an especially wide variety of circumstances (Johnson 1970), and other models, including the Newtonian one, can also under appropriate circumstances be usefully applied to sediments and rocks (Johnson 1977; Ramberg 1981; Johnson & Fletcher 1994). The responses of an unconsolidated sediment differ significantly according to whether the deforming force lies within the elastic range or exceeds by an appropriate factor the yield strength of the sediment and causes plastic flow.

(c) *Elastic region*

In the elastic region, very small, reversible strains arise in the material affected by a deforming force. Consider the action of a loaded, circular punch on a large, uniform material considered to be incompressible and elastic-plastic. As in the case of a strip load (Lambe & Whitman 1969, fig. 32.9), illustrated in figure 2, the punch sets up an axially-symmetric pattern of displacements within the material. These decay with depth and are negligible below about one punch-diameter. The

displacement is downward and outward in a zone beneath the punch, which descends slightly. Surrounding this zone is another in which the displacement is outward and upward, an annular, surface bulge surrounding the punch in compensation for the incompressible material forced from beneath. When the punch is unloaded, the displacements are reversed and the material returns to its original configuration. There is no surviving mark to indicate what has happened because there was no permanent deformation.

Most unconsolidated sediments show elastic behaviour, but normally over only a range of very small deforming forces. Some unconsolidated sands, however, have such a close grain packing (e.g. plane beds on beaches) that their response to vertical loading by a foot is purely elastic, the small, permanent deformation (scuffing) that is seen recording horizontal shear as the foot rotates during a stride.

(d) *Plastic region: general*

Permanent and continuing distortion by plastic flow becomes possible if the deforming force exerted through an indenter exceeds by some factor the yield strength of the affected material, with the total displacement increasing until either the force is withdrawn or, in the case of a body which increases downward in strength, the punch descends to an horizon sufficiently firm as to arrest the motion. The displacement may now be large or very large, and will increase with the degree of intrusion of the punch into the material.

The conditions for steady yield and the deformation pattern at incipient yield vary with the shape of the

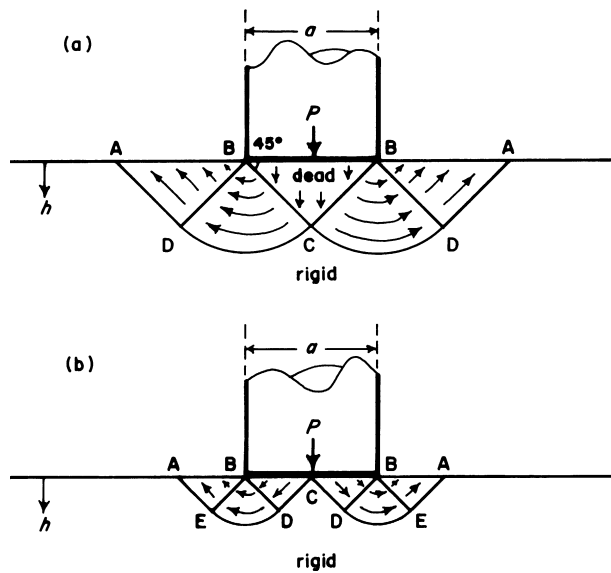

Figure 3. Theoretical slip-line fields during the steady indentation of a semi-infinite, ideal plastic material. (a) Punch rough (after Calladine 1969; Johnson *et al.* 1982). (b) Punch smooth (after Hill 1971).

indenter and a number of boundary conditions, as has been demonstrated for ideal plastics employing various theoretical techniques (Calladine 1969; Hill 1971; Johnson *et al.* 1970, 1982), and recently, using rheologically more complex materials (Hill *et al.* 1989; Hill 1992; Bower *et al.* 1993). Two of these conditions are particularly important in the context of tracks in sediments: the extent of the elastic-plastic material in relation to the size of the punch, and whether or not the material adheres to the face of the punch. Also of some importance is whether or not a shallow, indented layer adheres to the stratum beneath. Many tracks are made in deposits which are interstratified (in addition to being laminated) on a scale approaching that of the foot, or which increase continuously but rapidly downward in strength, with the effect of introducing a virtual stratal boundary. Watery sediments are likely to stick glutinously to the sole and sides of a foot, whereas drier ones may display no significant cohesion, while accepting near-perfect anatomical detail.

(e) *Semi-infinite plastic region*

Assuming strain in two-dimensions only (plane strain), the undistorted thickness, h , of the indented layer must theoretically be large compared to the width, a , of the indenter: $h > 4.38a$. When the face of the indenter is rough (figure 3a), the yield-point load for steady plastic deformation takes an upper bound of $P = 2ka(1 + \pi/2)$, where P is the unit force and k is the yield strength, the slightly smaller lower bound being $P = 5k$ (Prandtl 1920; Shield & Drucker 1953; Calladine 1969; Johnson *et al.* 1982). Immediately beneath the indenter occurs a triangular 'dead' region, BBC, in which the material simply moves downward with the punch, as in laboratory experiments illustrated by Johnson *et al.* (1982) and Tapponnier *et al.* (1982). In the adjoining regions ABCDA the material moves along the slip-lines sketched. Rigid material occurs

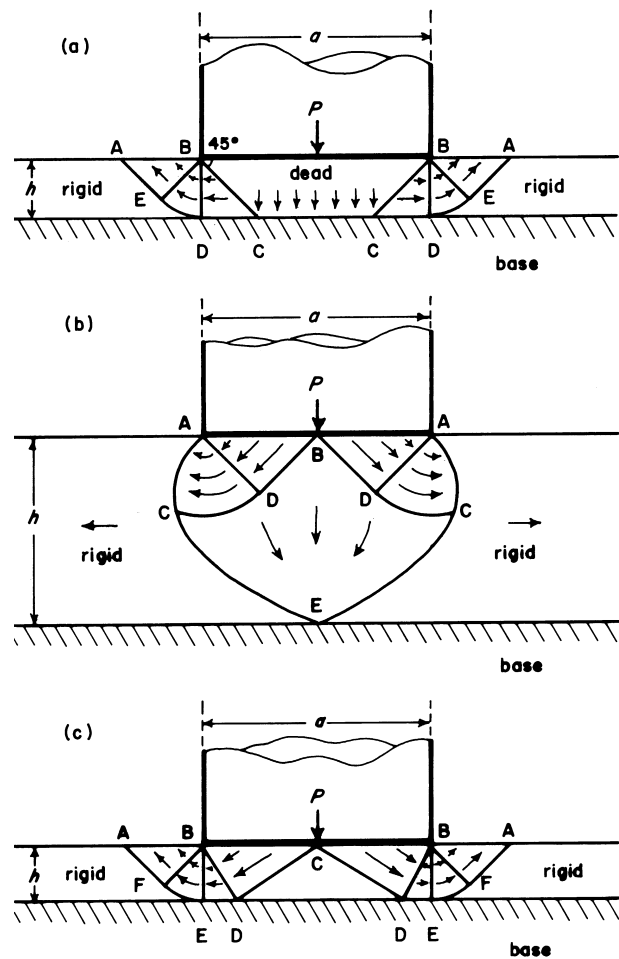

Figure 4. Theoretical slip-line fields during the steady indentation of a finite, ideal plastic material. (a) Punch and base both rough (after Shield 1955). (b) Punch and base both smooth (after Hill 1971). (c) Punch smooth, base rough (after Shield 1955).

beneath ABCDA. Note that heave may be expected at the exposed surface, creating marginal ridges, and that the deformed zone is in total three times wider than the indenter. For a perfectly smooth punch (figure 3b) the same bounds are obtained, but the slip-line field is different and without a dead zone (Shield & Drucker 1953; Levin 1955; Hill 1971). The width of the deformed zone is now only twice that of the indenter. A dead zone limited to a part of the underside of the punch may be expected when the indenter is neither perfectly smooth nor perfectly rough.

(f) *Finite plastic region*

A wider range of cases arises when $h < 4.38a$, since one or both of the indenter and the base of the affected layer may be either rough or smooth. Yield-point loads are greater than in the general semi-infinite problem, increasing gradually with a/h (Shield 1955). A trapezoidal 'dead' region, BCCB, extending through the thickness of the plastic material (figure 4a) is expected when both the punch and the base of the layer are rough (Shield 1955). Hill (1971) calculated the deformation shown in figure 4b for a smooth base and punch. Deformation follows the pattern in figure 4c when the punch is smooth but the base is rough (Shield

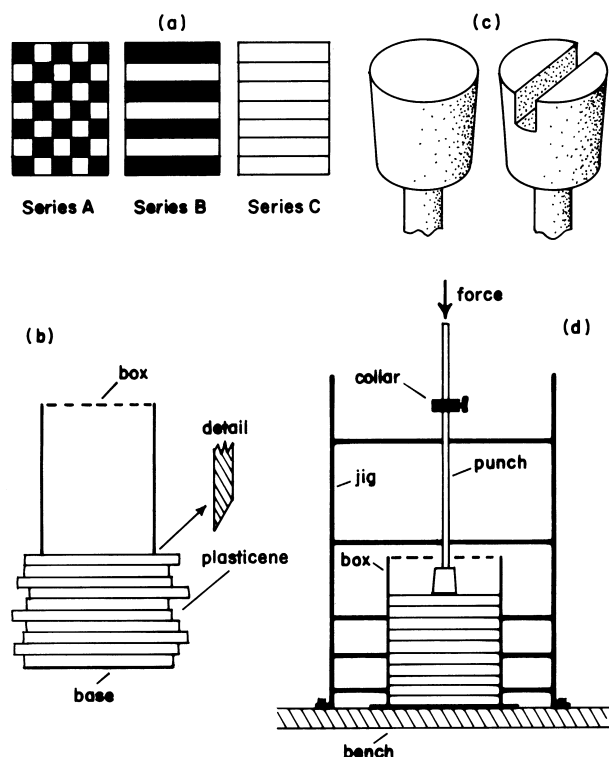

Figure 5. Materials and equipment for laboratory experiments on tracks. (a) Arrangement of Plasticine markers and layers (series A: adhesive square prisms of two colours; series B: adhesive horizontal layers in two colours; series C: non-adhesive horizontal layers). (b) A pile of markers/layers ready to be captured in the box. (c) Lower faces of smooth and slotted punches. (d) Box containing layered Plasticine mounted in jig ready for an experiment.

1955). In each case, heave and a pair of marginal ridges may again be expected at the exposed surface, but the width of the deformed zone is now between approximately a and $2a$, decreasing as a/h grows larger.

(g) **Conclusion**

The above summary of mechanical theory, although describing with highly simplified conditions, offers a number of insights into the likely character of the animal tracks present in the field. In particular, it suggests that (a) the shaft is surrounded by a substantial deformed zone, (b) the deformed zone is likely to include faulted as well as folded layers, and (c) the character of a track is likely to vary with the ‘rheological stratigraphy’ of the affected sediment.

4. LABORATORY EXPERIMENTS ON TRACK-MAKING

(a) **Materials and methods**

In these essentially qualitative laboratory experiments, a contained block of elastic-plastic material held in a simple jig was pierced to a prescribed depth normal to its upper surface by a right-cylindrical punch with a smooth face. The head of the punch was either plane or bisected along a diameter by an inset, rectangular slot.

Fresh Plasticine served as the modelling material (Green 1951; McClay 1976) because it was cheap, available in various colours, and readily shaped and glued. It is virtually incompressible, has a well-defined

Table 1. Summary of conditions for laboratory experiments on track-making. Note: all values are nominal

experiment	punch diameter (a /mm)	slot width (b /mm)	slot height (c /mm)	layer thickness (h /mm)	penetration depth (d /mm)	h/a	d/a	d/h
A1	32	plane	plane	42	4	1.31	0.125	0.095
A2	32	plane	plane	58	8	1.81	0.250	0.138
A3	32	plane	plane	75	16	2.34	0.500	0.213
A4	32	plane	plane	91	32	2.84	1.00	0.352
A5	32	plane	plane	91	48	2.84	1.50	0.527
A6	32	plane	plane	42	32	1.31	1.00	0.762
A7	32	plane	plane	25	25	0.781	0.781	1.00
B1	32	8	4	34	4	1.06	0.125	0.118
B2 ^a	32	8	4	51	8	1.59	0.250	0.157
B3	32	8	8	68	16	2.13	0.500	0.235
B4 ^a	32	8	8	80	32	2.50	1.00	0.400
B5	32	8	8	80	48	2.50	1.50	0.600
B6	32	8	8	34	24	1.06	0.760	0.706
B7 ^a	32	plane	plane	23	23	0.718	0.718	1.00
B8 ^{ab}	32	plane	plane	23	23	0.718	0.718	1.00
C1	32	8	4	48	4	1.50	0.125	0.083
C2	32	8	4	57	8	1.78	0.250	0.140
C3	32	8	4	88	16	2.75	0.500	0.182
C4	32	8	8	60	8	1.88	0.250	0.133
C5	32	8	8	86	16	2.69	0.500	0.186
C6	32	4	4	48	4	2.34	0.125	0.083
C7	32	4	4	68	8	2.13	0.250	0.118
C8	32	4	4	88	16	2.75	0.500	0.140

^a Experiment repeated to provide transverse sections.
^b Face of punch and base of Plasticine block lubricated.

PHILOSOPHICAL TRANSACTIONS OF THE ROYAL SOCIETY OF BIOLOGICAL SCIENCES

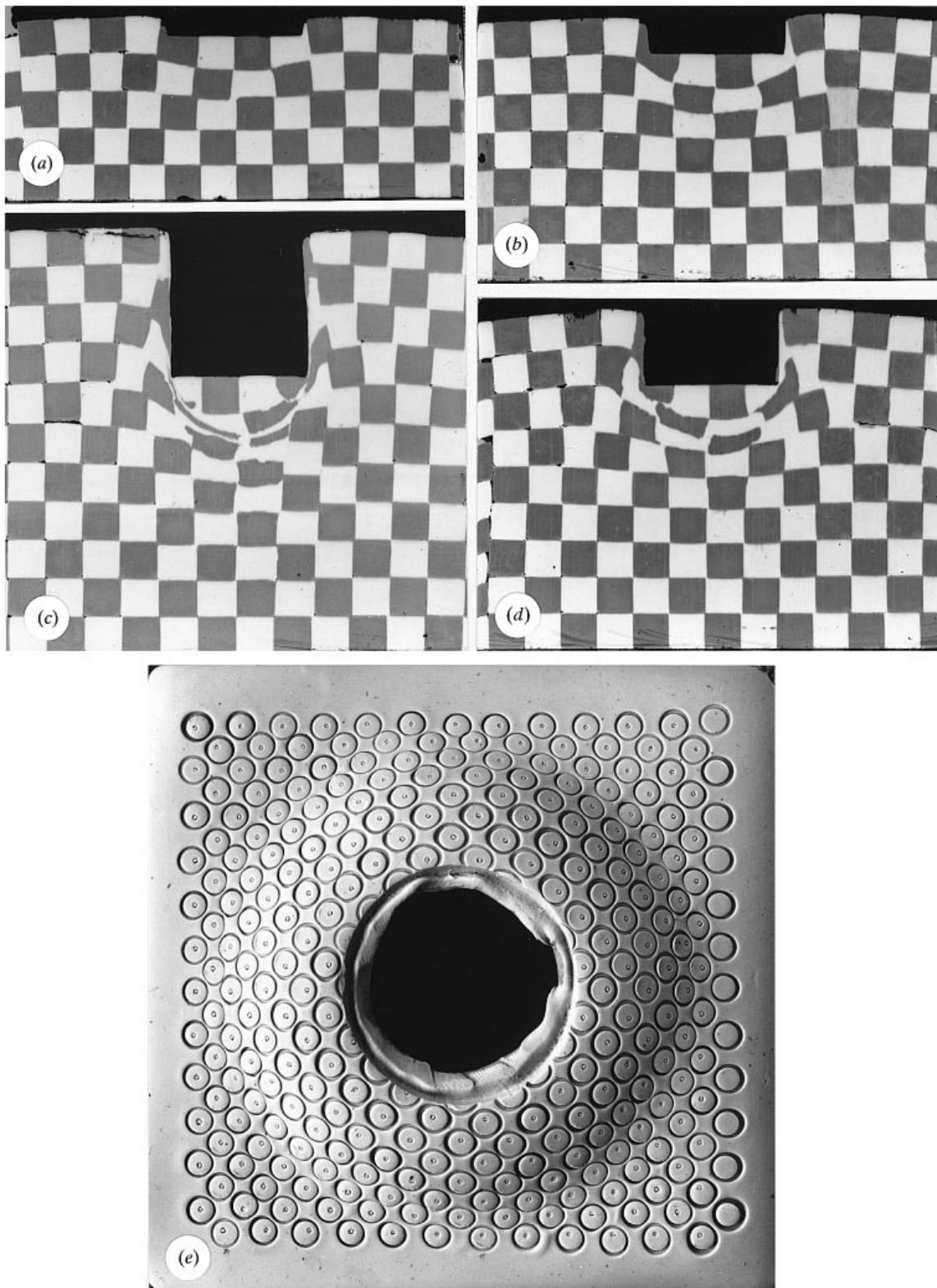

Figure 6. Laboratory experiments on track-making: displacement fields (Series A, axial sections) and surface strain markers (Series B). Each photograph illustrates a subject about 105 mm across. (a) Experiment A1. (b) Experiment A2. (c) Experiment A4. (d) Experiment A3. (e) Initially circular strain markers on upper surface of Plasticine block in Experiment B7. See table 1 for experimental details.

yield point, exhibits only a weakly nonlinear flow law and, at high strains, shows no work-hardening when warm. The experiments are in three series, differing chiefly in the construction of the masses of Plasticine to be shaped into contained blocks and then pierced by the selected punch (figure 5*a*). Except in one experi-

ment, each mass was firmly glued to the rigid base on which it was built up. In Series A, intended to demonstrate modes of deformation and displacement fields, square prisms (side 8.3 mm) of alternately light- and dark-coloured Plasticine made using a pug mill are pressed and glued together to form a square-based

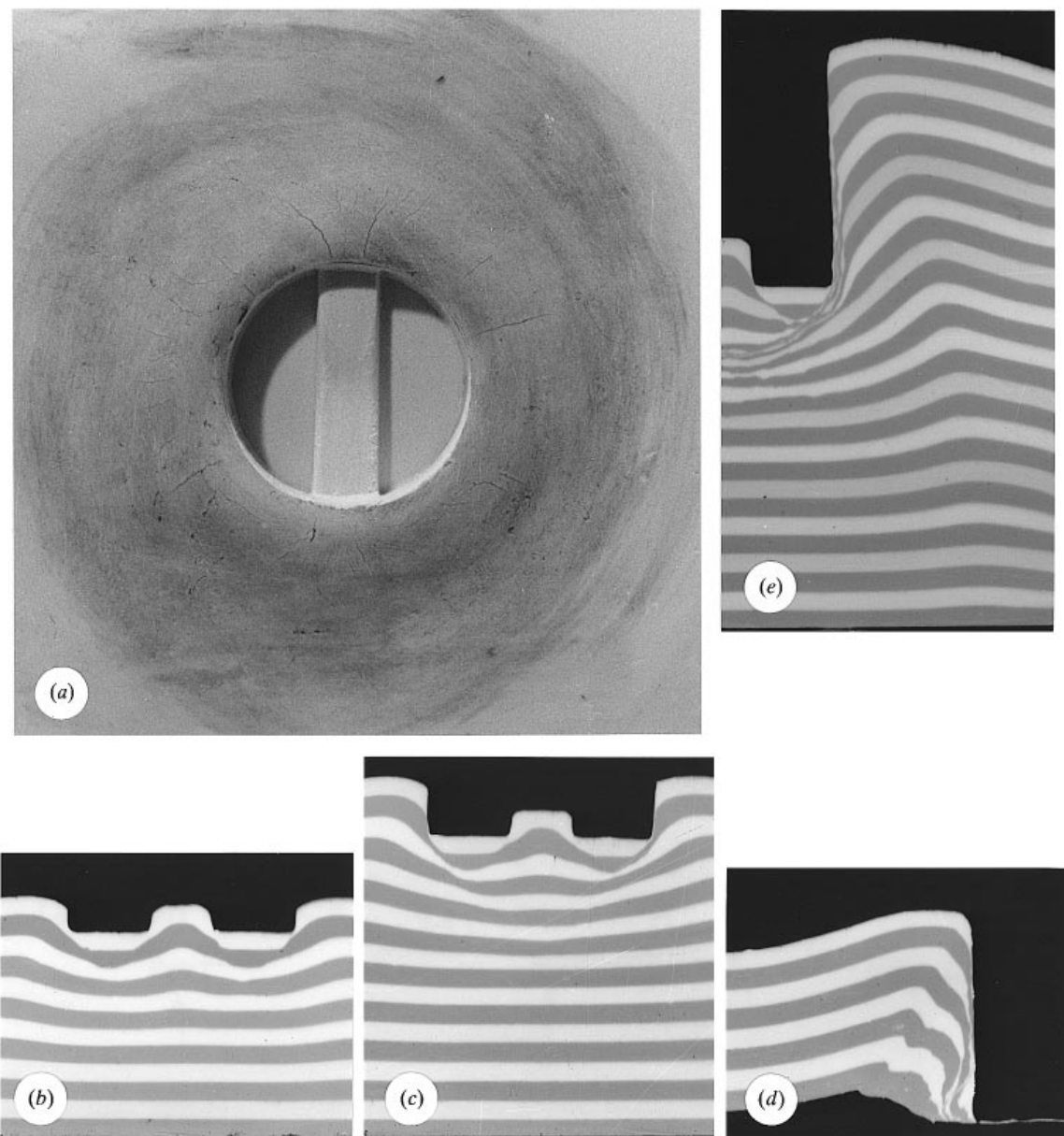

Figure 7. Laboratory experiments on track-making: small-scale features associated with deformation (series B, axial sections). Except where a portion is specified, each photograph illustrates a subject about 105 mm across. (a) Radial fractures due to circumferential tension on the upper surface of Plasticine block, experiment B2. (b, c) Microfaults associated with shear zones beneath 'footprint', Experiments B1 and B2. (d) High-angle microfaults close to shaft wall and microthrusts beneath marginal upfold, Experiment B8 (left-hand portion; see figure 9*k* for right-hand part). (e) Microfaults associated with the shaft wall (high-angle) and the 'dead region' below the 'footprint', Experiment B4 (right-hand portion). See table 1 for experimental details.

mass (side *ca.* 140 mm) of the desired height. These prisms, in cross-section, serve as strain markers. Masses for Series B and C are built of stacked layers of Plasticine rolled on plane glass to a uniform thickness of 2.85 mm; these stacks are intended to simulate the laminated deposits so frequently encountered in the field. Alternately light and dark layers are glued together in Series B, but in Series C they are of a single colour and dusted with powdered talc to make them non-adhesive, except for the underside of the lowest layer which, as described, was glued to the base. The endeavour in Series B is to explore the geometry of deformation in a layered but essentially homogeneous material. The stacks for Series C mimic sediments composed of sharply contrasting layers. Because of the

lack of adhesion other than at the base, these blocks can, after deformation, be dissected a layer at a time, affording insight into the progressive loss of anatomical detail downward through undertraces (see figure 1*a*).

Each block was contained in a cube-shaped metal box (side 105 mm internally), with upper and lower faces open, divisible into two L-shaped parts by withdrawing pins from hinge-like fastenings along opposite vertical edges. A block was formed by pressing the box into one of the masses of Plasticine supported on its base, fashioned as described above (figure 5*b*). The blocks in each series may be regarded as identical, within the limits imposed by the hand-construction of the parent stacks. The punches to pierce the blocks are cylindrical (diameter 32 mm), with plane or slotted

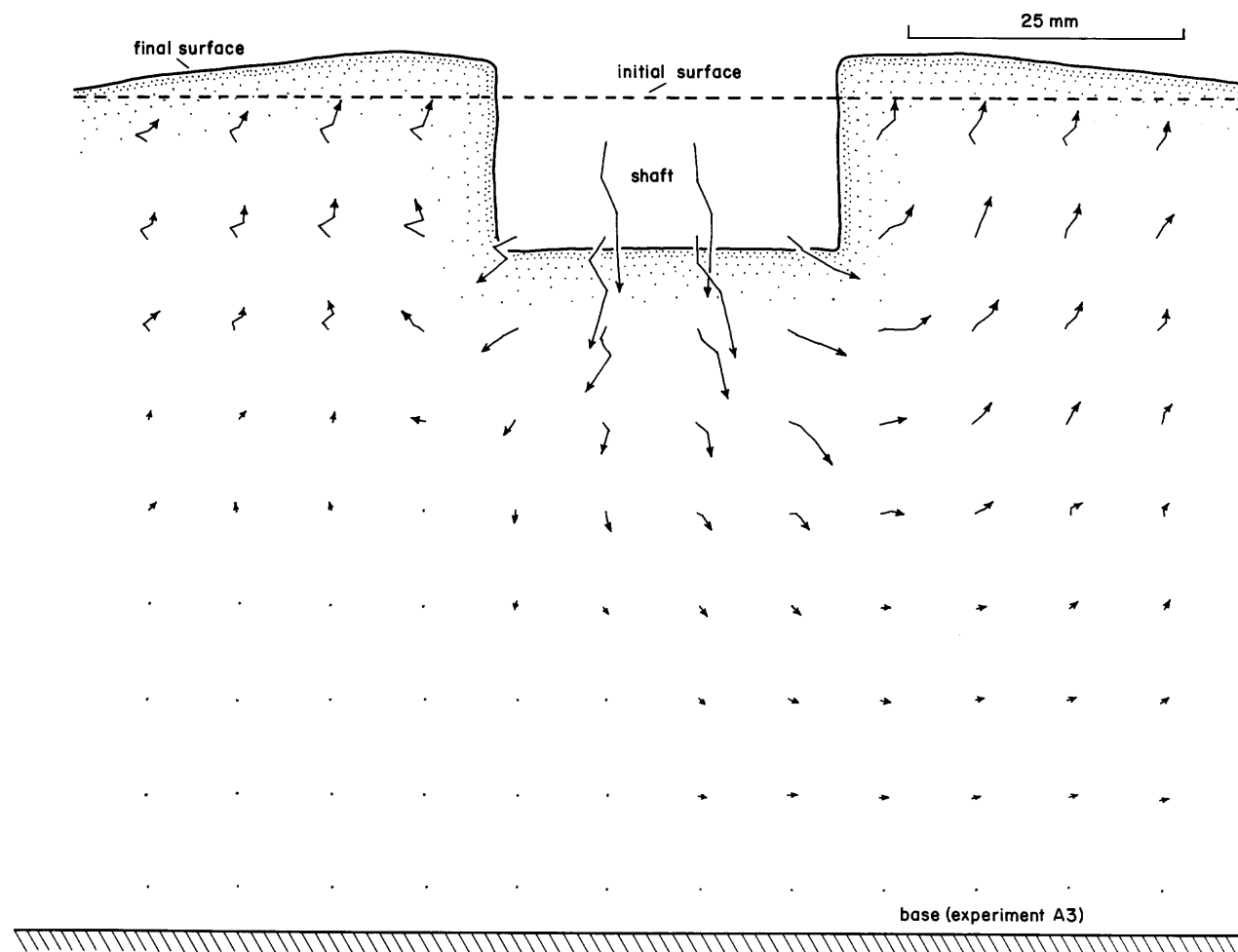

Figure 8. Experimental displacement field reconstructed from the positions of the axes of square prisms of identical size and arrangement in an undeformed block of prisms and in three increasingly deformed blocks (Experiments A1–A3). See table 1 for full experimental conditions.

faces, and made from hardwood mounted axially on a stout steel rod (figure 5c). The slotted forms simulate the divided hooves of cervids and bovids, the mammals chiefly represented by tracks in the Flandrian deposits of the Severn Estuary.

In order to make an experiment, the contained Plasticine block was secured in a simple jig on the laboratory bench (figure 5d). Over a period of a few seconds, a steady downward force was applied manually through the rod to the punch, the penetration of which was limited by an adjustable collar. In Series A and B, the blocks, wrapped in plastic sheets, had been heated in an oven for 18 h at about 40 °C in order to soften them; the punch was also preheated. These experiments were carried out as soon as possible after removing the punch and block from the heat. The blocks were used at room temperature in Series C, in order to prevent layer adhesion. After completion of an experiment, the punch was carefully removed, the shaft quickly filled with hot black Plasticine, and the block allowed to cool. The box was removed from around the block by withdrawing the corner pins and the mass (Series A, B) transferred to another jig in which it could be cut serially into parallel slices of controlled thickness and photographed. The orientation of these slices may be described in the same terms as for naturally occurring tracks (see above).

Blocks from Series C were dissected and photographed in the jig by peeling off layers in sequence from the topmost downwards. Fractures on the upper surfaces of blocks, and on the surfaces of layers in Series C, were made clearer by applying a paint of Indian ink, followed by the careful removal of the surplus.

(b) Mode and intensity of deformation

Blocks from Series A (table 1) were sliced axially along the shaft and normal to the lie of the Plasticine prisms (figure 5a). They show that the Plasticine deforms around the descending punch chiefly by pure shear, but with some simple shear and rotation of elements (figure 6a–d). At large strains, some unglueing and slippage of the Plasticine prisms may be evident. Beneath the face of the punch is a narrow, roughly hemispherical zone of intense shear that bounds a 'dead' region, as in the experiments of Johnson *et al.* (1982) and Tapponnier *et al.* (1982) (see figure 3a). Upward displacement and vertical extension due to a much less intense radial compression is evident laterally from this zone and from the wall of the experimental shaft. The surfaces of the blocks are arched up around the shaft and, judging from patterns of faint surface cracks, in radial tension within a narrow, annular zone commencing at the lip. Along

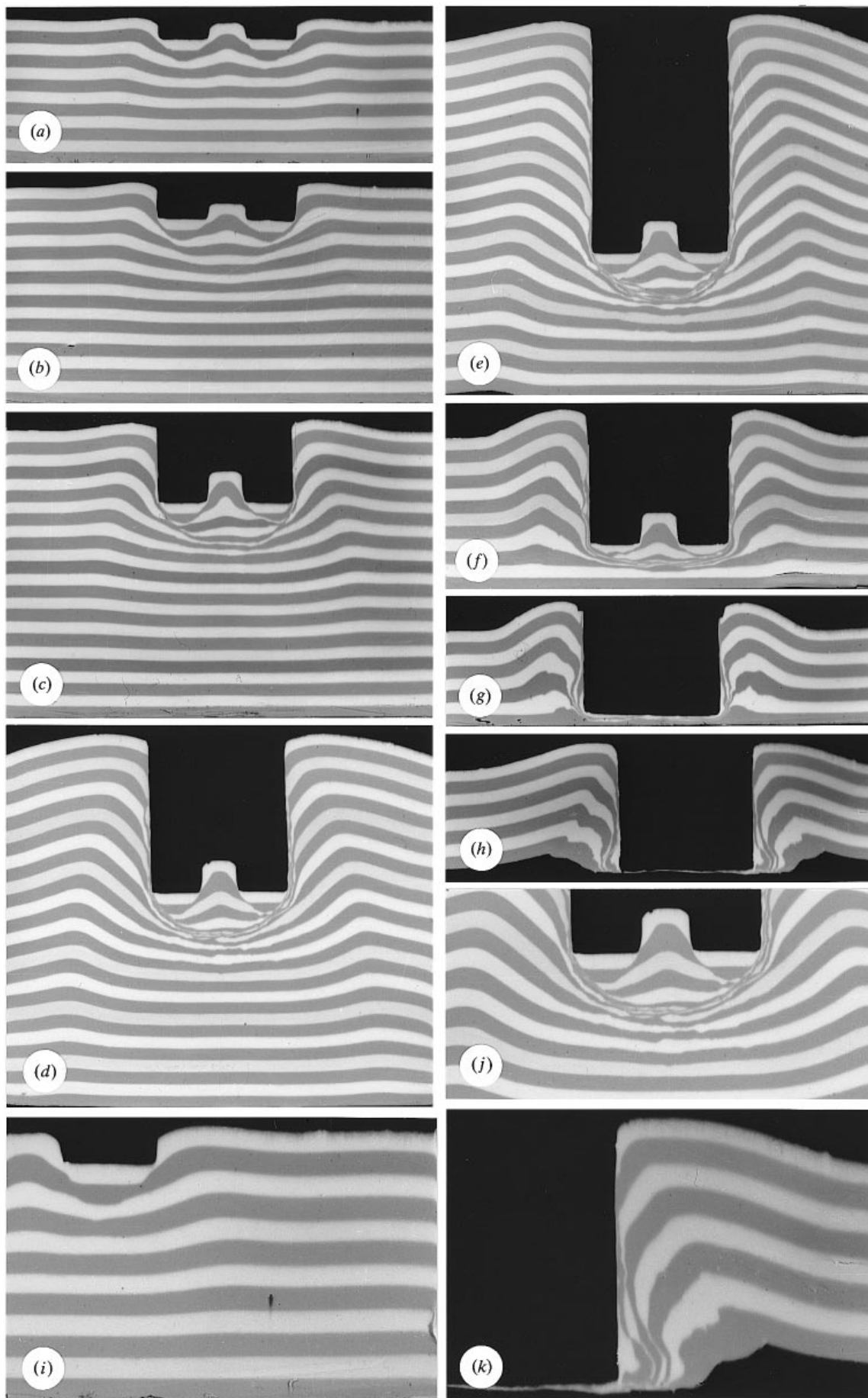

Figure 9. For description see opposite.

and just outward from the crest of the arch, however, circumferential tension exists compatible with a detectable radial compression and slight outward displacement of elements (figure 6*a–d*). Green (1951) and Johnson *et al.* (1982) found upward and outward displacement in their experiments; the simple doming experiments of Withjack & Scheiner (1982) and Marti *et al.* (1994) produced radial fractures and a radial compression expressed internally and at the surface by outward micro-thrusts. Blocks that were deeply penetrated showed intense strain (e.g. table 1, A5–A7). As the punch approaches closer to the base of the deformed layer, the state of circumferential tension at the surface spreads inwards toward the lip of the shaft, as shown by strain markers in an experiment from Series B (figure 6*e*, table 1, B7) and surface cracks revealed by a paint of Indian ink in another case (figure 7*a*, table 1, B2).

Figure 8 shows the displacements of the centres of prisms observed from an unpierced block and experiments A1–A3, with the base of the blocks serving as datum (table 1; figure 6*a, b, d*). All four blocks were identical in construction. As the theoretical model demands (figure 3), and as Lambe & Whitman (1969, fig. 14.3) illustrate from a related experiment using uniform glass rods, material is displaced downward and sideways beneath the punch, and upward and slightly outward in the outer part of the deformed zone. However, the displacement field yielded by the present experiments is not exactly symmetrical, as required theoretically, on account of a systematic distortion found to have been introduced as the result of the way of building up the mass of square prisms.

(c) Geometry of deformation

The deformation of blocks of homogeneous, layered Plasticine by a slotted or plane punch is illustrated in figure 9*a–h* (table 1, B1–B8), the section in the slotted case being cut normal to the length of the slot. The changing transverse section is illustrated by serial slices from experiments B2 and B4 (figure 10). Essentially, the punch creates a deformed zone composed of (a) an annular upfold beneath a marginal ridge on the surface that surrounds (b) an axial downfold; when the punch is slotted, the floor of the downfold may include (c) a small slot-related cross-fold. The basic geometry may be described using the measures defined in figure 11*d*.

In all the experiments the upfold is asymmetrical and faces the axis of the shaft, the inter-limb angle increasing downward. The relative length L_1/a at the crest increases at first rapidly and then more gradually, with little difference between the trials (figure 11*a*), but the relative length L_2/a between the hinge points is constant only for small penetrations (figure 11*d, e*).

Downward, the crest and outer hinge of the upfold gradually converge, leaving only the axial downfold at greater depths (figure 9*c*). The relative height, H_1/a , of the downfold falls off downward, typically on an inflected curve (figure 11*b*), but the relative height, H_2/a , is steadier (figure 11*c*).

Increasing penetration effects two main changes. The upfold and downfold increase in strength (figure 9*a–e*) and, as in Series A (figure 6*a–d*), a semicircular zone of increasingly intense shear develops around the ‘dead’ material (e.g. figure 9*d*). Transversely, the increasingly intense folding is expressed in several ways. Within the vertical range of the shaft, a growing number of layers are seen to be involved (figure 10*a, f, g*). Slices from about the level of the ‘footprint’ vary downward from simple in structure, with a clear slot-related cross-fold, to more complex and confused a little below (figure 10*b, c, i, j*). Only at greater depths is there evidence of a broad, flat-bottomed basin (figure 10*d, e, k, l*). At small penetrations (figure 9*a, b*), the relative length, L_2/a , is about two (figure 11*d*), corresponding well with the scale of the deformed zone in the theoretical rough-punch model (figure 3*a*). At greater penetrations, the deformed zone seems at first to widen at the surface toward $L_2/a = 3$ and then narrow, while narrowing rapidly downward (figures 9*c–h*, 11*d, e*). The theoretical models for plastic layers of finite depth suggest a narrowing of the deformed zone as the punch increases relatively in size (figure 4).

Shear zones arise at a number of sites within the blocks. With growing penetration, they become increasingly obvious at the lateral margin of the shaft and also beneath the punch. The marginal ones first appear at about $d/a = 0.5$ (e.g. figure 9*c*). They are closely spaced, dipping inward and outward at 70–80° (e.g. figures 7*d, 9e*), and may correspond to (much shallower) slip lines in the models (figures 3, 4). A better fit to the theoretical models is afforded by the axially symmetrical shear zones that extend obliquely downward and inward from the outer edges of the punch and slot (figures 7*c–e* and 9*i*). Crossing semicircular zones of intense layer-thinning, these dip at about 45° and seem to match the shear zones at the boundaries of the predicted ‘dead’ regions. The uneven thicknesses (figure 9*c–f*) and crenulate margins (figure 10*j*) of these thinned layers beneath the punch are suggestive of Kidan & Cosgrove’s (1996) ‘pinch-and-swell’ structures, produced by vertical-normal compression. As the punch cuts deeper into the blocks, an increasing amount of Plasticine is compressed vertically and squeezed outward. The displaced material forms a wide-angled, almost flat-lying fold which is partly thrust, along steep reverse shear zones, beneath the outer limb of the upfold (figures 3*d, 9g, k*).

A deformation geometry similar to the above arises

Figure 9. Laboratory experiments on track-making: effects due to penetration and layer-thickness (Series B, axial sections). Except where a portion is specified, each photograph illustrates a subject about 105 mm across. (a) Experiment B1. (b) Experiment B2. (c) Experiment B3. (d) Experiment B4. (e) Experiment B5. (f) Experiment B6. (g) Experiment B7. (h) Experiment B8. (i) Experiment B1, detail of microfaults beneath the ‘footprint’ (right-hand portion). (j) Experiment B4, detail of folds and microfaults associated with the ‘dead region’ and shear zone beneath the ‘footprint’ (shaft 32 mm across). (k) Experiment B8 (right-hand portion). See table 1 for experimental details.

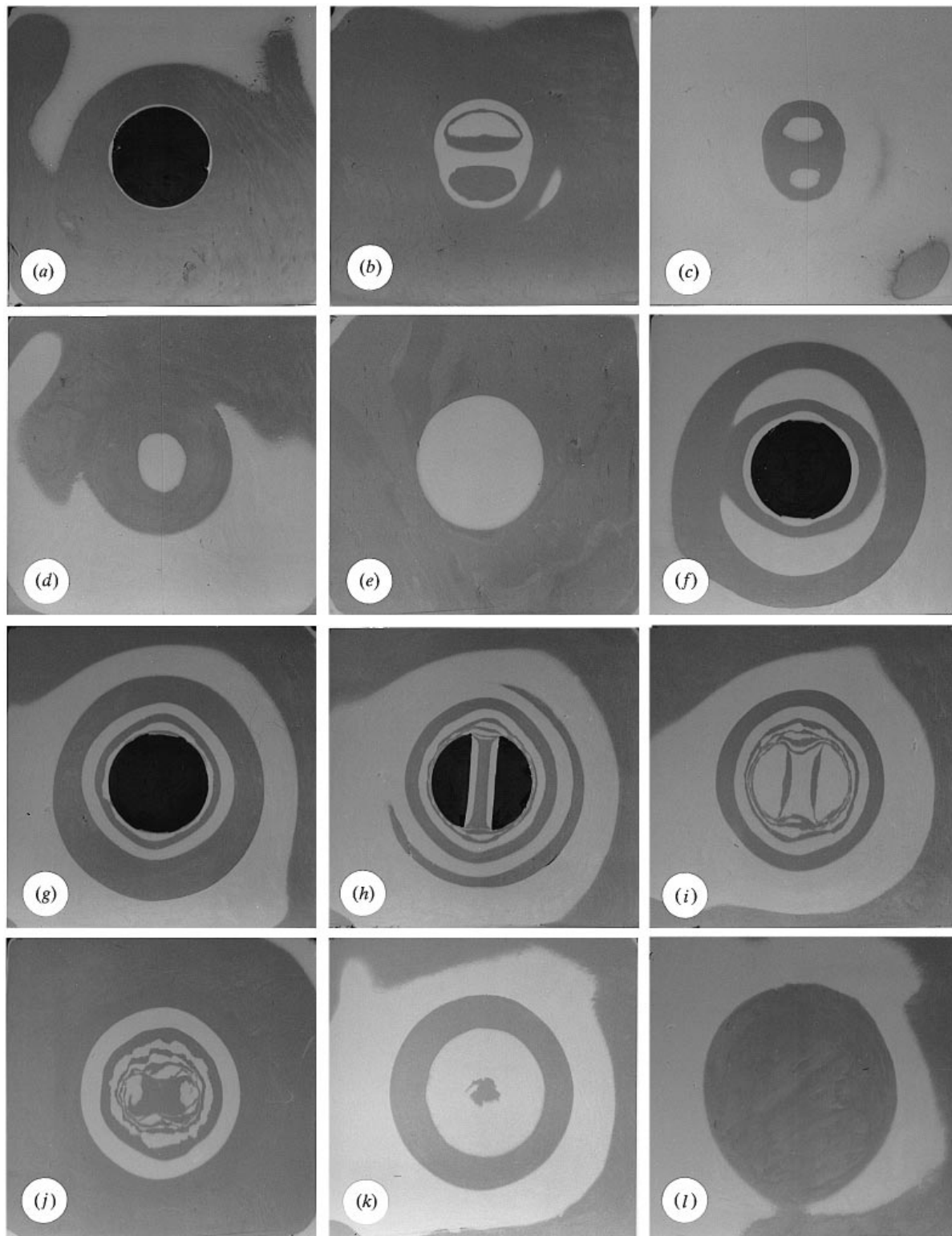

Figure 10. Laboratory experiments on track-making: transverse sections (Series B). Each photograph illustrates a subject about 105 mm across. (a–e) Experiment B2, a section high across the shaft (black) and at progressively increasing depths below the level of the footprint. (f–l) Experiment B4, sections across the shaft (black), across the shaft and slot, and at progressively increasing depths below the level of the footprint. See table 1 for experimental details.

in the blocks composed of non-adhesive layers (table 1, Series C). The main qualitative differences from Series B are (a) a more subdued marginal upfold, and (b) a corresponding partial suppression of the shear zones generated at sharp edges on the punch. Quantitatively,

the main change is a range of higher values for L_1/a (figures 11 *a, b* and 12).

The field observer is commonly presented with non-axial vertical sections of tracks, represented experimentally in figure 13 *a–g* (see also table 1). Depending

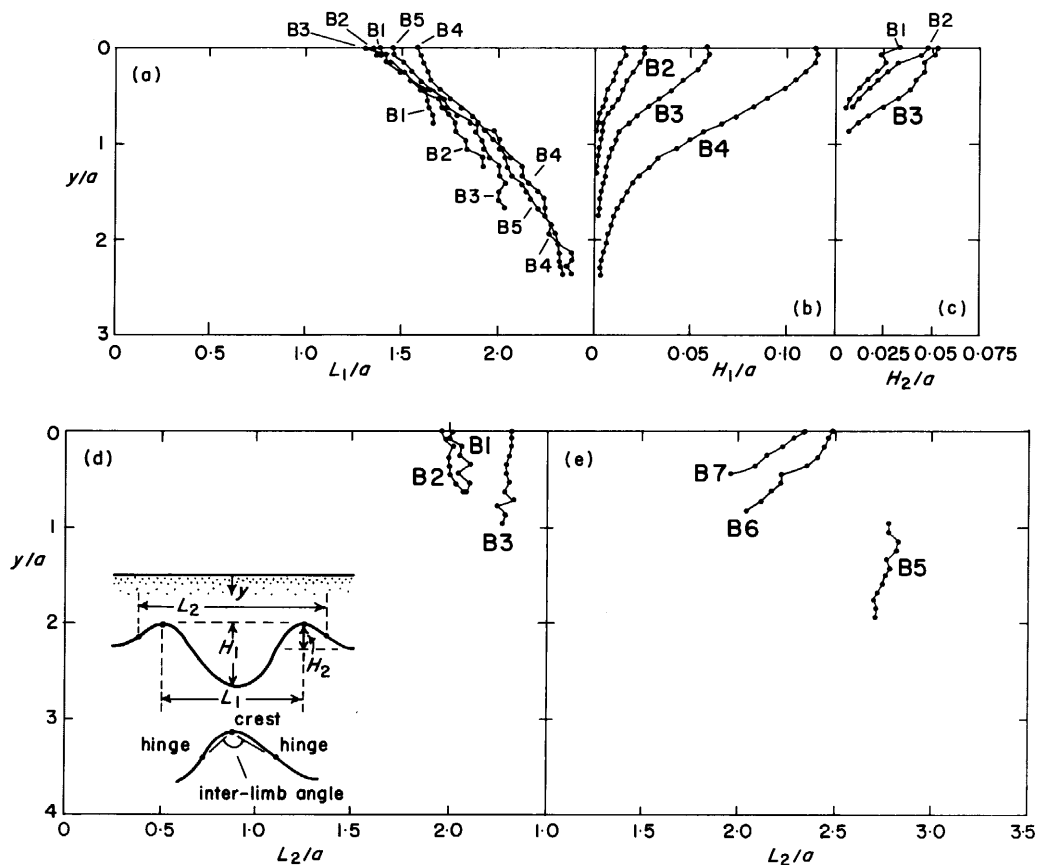

Figure 11. Laboratory experiments on track-making (Series B). Aspects of the geometry of the deformed zone. See also table 1.

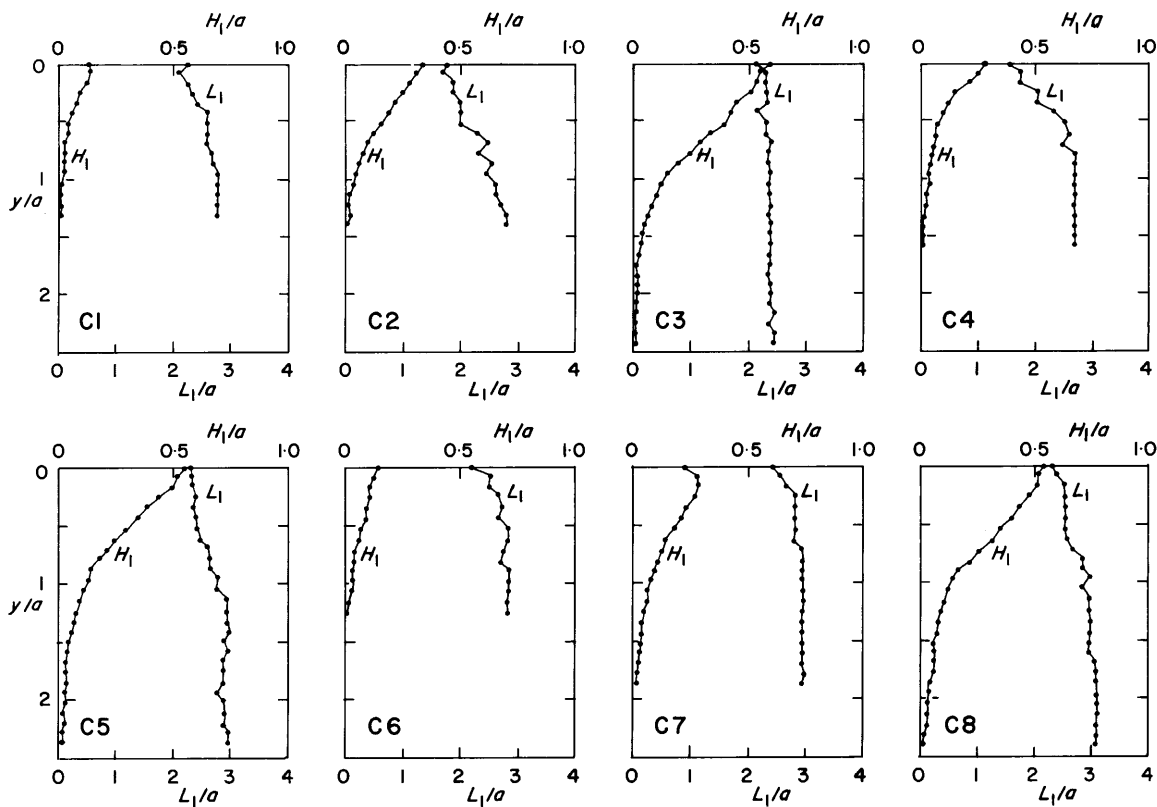

Figure 12. Laboratory experiments on track-making (Series C). Further aspects of the geometry of the deformed zone. See figure 11 for definition diagram and also table 1.

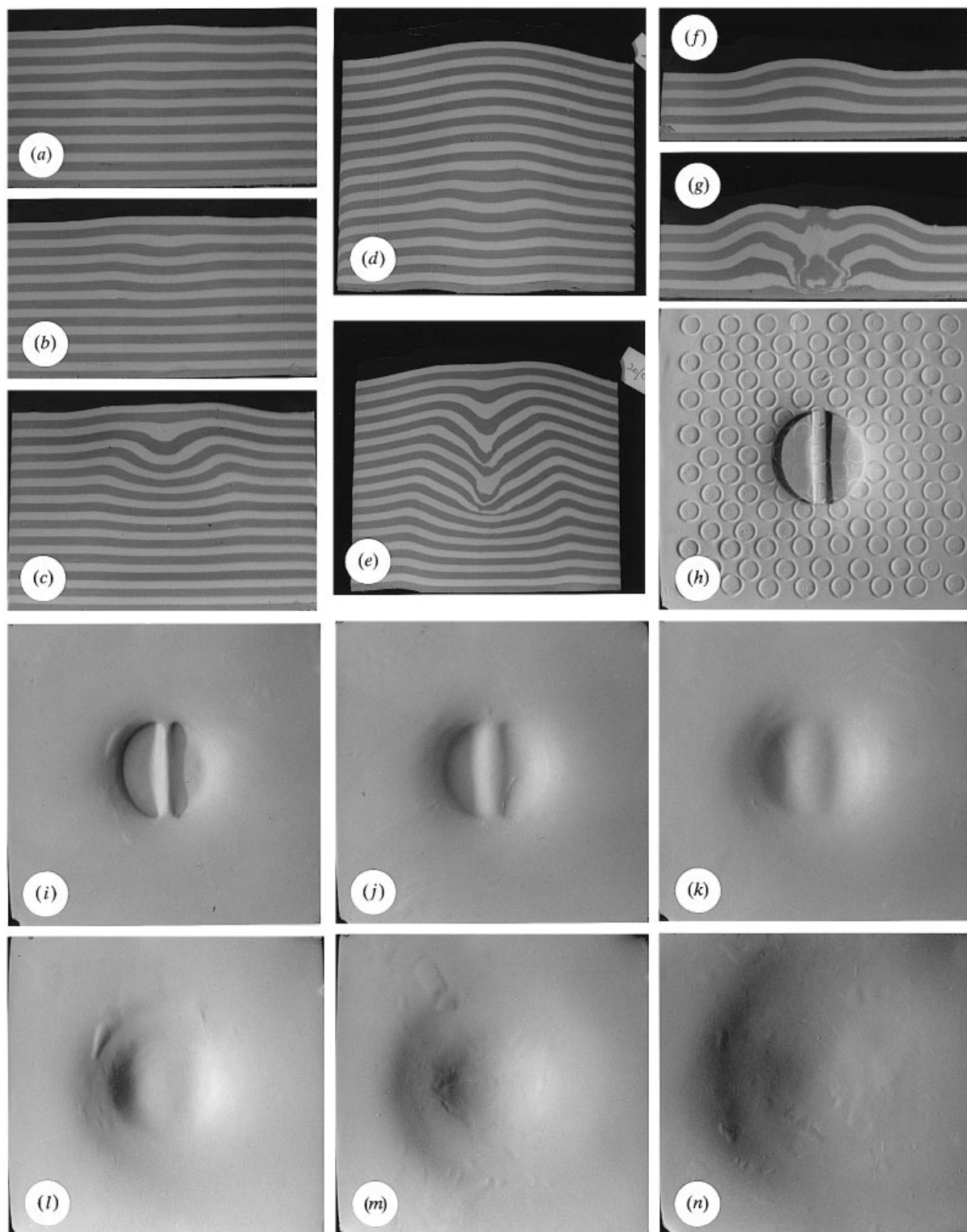

Figure 13. Laboratory experiments on track-making: external-vertical sections (Series B) and views of non-adhesive bedding surfaces (Series C). Each photograph illustrates a subject approximately 105 mm across. (a-c) Experiment B2, three external-vertical sections at progressively shorter distances from the concealed shaft wall. (d, e) Experiment B5, two external-vertical sections progressively closer to the concealed shaft. (f, g) Experiment B7, two external-vertical sections progressively closer to the concealed shaft. (h-n) Experiment C7 (light from left), the surface of the indented Plasticine block (with strain markers) showing the empty shaft, and six bedding surfaces at progressively greater depths below the shaft. See table 1 for experimental details.

on their relative axial distance, such sections may be recognized by either (a) vague undulations in laminae, (b) a pair of folds of downward decreasing height that grow out of a single upfold, or (c) closed bedding traces, as in a sheath fold, indicative of a fold nose.

(d) Features due to a slot

A slot on the face of the punch, simulating the interdigital cleft on the hooves of cervids and bovids, creates various minor structures on the floor of the

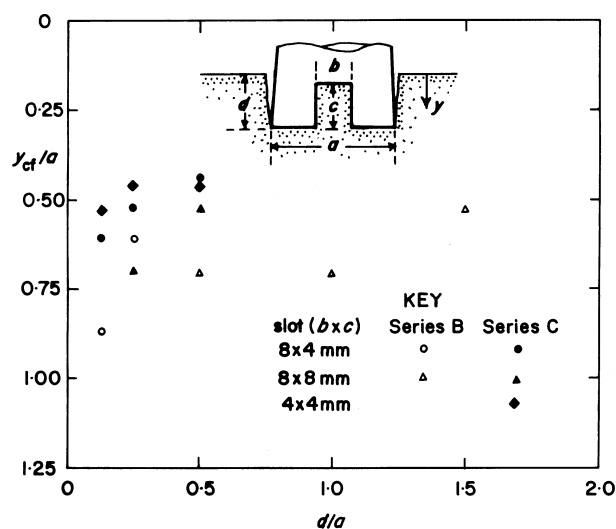

Figure 14. Laboratory experiments on track-making (series B and C). Effect of penetration (d) on the depth in the material (y_{ct}) at which a slot on the base of the punch is no longer detectable. Note that y_{ct} is measured relative to the *undisturbed* surface and not to the surface after deformation. See also table 1.

axial downfold. These are (a) the shear zones already described and (b) a cross-fold, shown axially in figure 9*a–e* (table 1, B1–5), transversely in figure 10*b, c* (table 1, B2, 3), and as features on the surfaces of layers in figure 13*h–n* (table 1, C7). The anticlinal cross-fold is most readily detected and simplest at small penetrations, when the shear zones are little developed.

Downward through the undertraces, the cross-fold declines in height but increases in the inter-limb angle, the minimum angle falling as the slot deepens (e.g. figure 9*a, c*). The cross-fold remains recognizable below the level of the footprint to relative depths, y_{ct}/a , of 0.45–0.85 (figure 14), increasing with the size of the slot, but decreasing with growing penetration, as more and more layers are entrained into the intensely sheared zone below the punch. Adhesion between layers appears to increase somewhat the relative depth to which the cross-fold can be traced.

(e) Conclusion

These experiments reproduce qualitatively (figures 6, 7, 9, 10, 13) all the essential features of real tracks (figure 1), and justify the choice of an indented plastic material (figures 3, 4) as an appropriate general theoretical model for the first stage in track formation. It would appear that the limb and foot cut a shaft in the sediment, creating around and below the shaft an extensive zone of deformed sediment, the degree of deformation increasing with penetration. The deformed zone comprises an axial downfold, in which are preserved downward-decaying undertraces, and a marginal upfold, together with shear and fracture zones. Where the sole of the foot is complex in shape, anatomical details, in the form of cross-folds, may to an extent be preserved among the undertraces, but only in those closest below the footprint.

5. TRACK-MAKING IN THE CONTEMPORARY SEDIMENTS

(a) Tidal and climatic regimes

The inner Bristol Channel and Severn Estuary constitute one of the largest tidal inlets on the west coast of Britain (Allen 1990*a*, 1991). With a hypertidal regime (extreme tidal range 14.8 m, Avonmouth) and an exposed setting (opening west to south-west), the system is swept by fast, turbulent currents frequently augmented by substantial storm waves and surges. Tidal heights are least during the late spring and summer, but otherwise fairly uniformly high. The climate is maritime, with a strongly seasonal distribution of sunshine, temperature, rainfall, and wind strength, direction and frequency (Chandler & Gregory 1976; Allen 1987*a*), the warmest, driest and calmest months extending from May to August; February can also be calm and dry. The tidal and climatic regimes are significant factors in track-making and track preservation, for they strongly influence the amounts of sediment accretion/erosion on the higher mudflats and salt marshes, together with the grain size, moisture content, and general strength of the deposits.

(b) Sedimentological background

Rivers draining areas of mainly Palaeozoic and Mesozoic rocks supply large amounts of fine sediment to the estuary (Collins 1987; Allen 1991), and there is a considerable short-term exchange of fines between the water body and the unstable bed and banks (Allen 1987*b*, 1990*a*). Although the bed-material coarsens from chiefly medium sand in the outer estuary to very fine sand in the inner part (McLaren *et al.* 1993), the suspended sediment becomes finer grained and more clay-rich down-estuary (Allen 1987*c*; French 1993). Roughly 10% of this sediment consists of carbonate particles, chiefly shell debris, and a full range of clay-mineral species is present, about 25% of the < 2 mm fraction consisting of expandable minerals.

Large amounts of suspended fine sediment at generally high concentrations (Hydraulics Research Station 1981; Kirby 1986) are potentially available for deposition at high-water slack on the salt marshes and mudflats. However, the accretion–erosion regime in these environments is extremely variable (e.g. Allen 1987*c*), and sensitive to spatio-temporal changes in tidal, wind-wave and other weather conditions, with consequent effects on sediment properties that control track-making (figure 15). Most deposition, and also most erosion, occurs from late autumn to early spring, when the tides are relatively high and strong, and westerly winds generally frequent. The sediment is coarsest during the winter, when sand is readily suspended owing to increased storminess and the elevating effect of low temperatures on water viscosity (Allen 1990*b*). Normally, accretionary and erosional events occur on time-scales ranging from the twice-daily tide, to a few days (strong-wind events), to a few weeks (spring-neap and monthly tidal cycles; late autumn–early spring storms). Seasonally, there is a greater

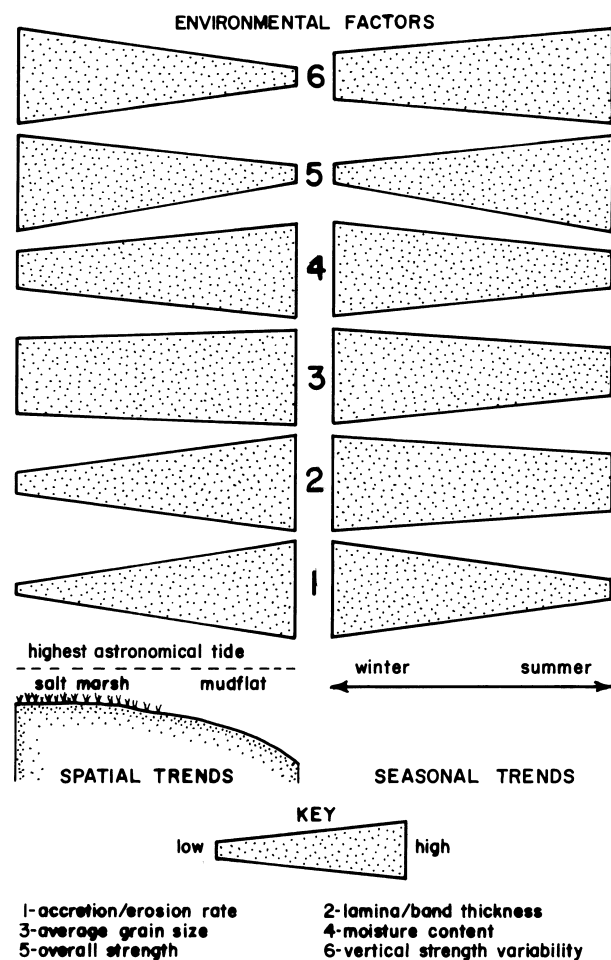

Figure 15. Summary of spatio-temporal trends in six environmental factors which influence the formation of animal tracks in the inner Bristol Channel and Severn Estuary. The spatial trends plotted are those observed in a transect across the mudflats and marshes. The main axial trends are an up-estuary decline in accretion/erosion rates, and an increase in the grain size of the mudflat-marsh silts.

tendency toward accretion during the summer months, and a heightened tendency toward erosion during the winter. There are, however, exceptions in particular years. Deposited mud can remain uneroded during winter anticyclonic conditions, when thicknesses totalling up to a few decimetres can form without interruption on the mudflats, and up to a few centimetres on the lower marshes, provided that periods of such weather follow each other in rapid succession. A single, severe storm, however, can remove these accumulations in their entirety, as well as some older sediment. Heavy rain and winter freeze-thaw also erode the higher intertidal sediments. Generally, little deposition takes place from the lower tides that prevail from late spring to late summer. During these periods, the silts underlying the salt marshes and higher mudflats lose moisture and become stronger, although the accompanying development of desiccation fractures (Allen 1987*a*) means that sufficiently powerful currents can erode them later in the form of relatively large masses. Those deposits highest in the tidal frame may dry out completely during a lengthy warm, dry period. Consequently, animals that inhabit the margins of the estuary encounter seasonally varying

sediment conditions that affect the character of the tracks they may leave behind. During any one season, however, sediment conditions also vary with position in the tidal frame, with moisture content declining, but strength increasing, upward and outward from the mudflats to the high salt marshes. The tidal and climatic regimes ensure that, from the standpoint of strength, the stratigraphically most variable sediments occur on the salt marshes; the mudflat deposits are generally speaking the weaker and more uniform vertically.

Because of the current high rate of relative sea-level rise (Heyworth & Kidston 1982; Shennan 1989; Allen 1990*b*), no peat marshes are being formed today on the margins of the estuary. Hence it has not been possible to conduct field track-making experiments in organic-rich sediments. It may nevertheless be reasonably assumed that, as sediments potentially able to receive animal tracks, the peats (reed swamp, fen-carr, coastal woodland, acid bog) that occur in the Flandrian sequence (see below) were weak at the time of formation and for a period afterwards. In contrast to the contemporaneous silts, they would also be highly and, to a substantial extent, irreversibly compressible.

(c) *Larger mammalian inhabitants*

In the contemporary estuary, the potential makers of tracks on the higher mudflats and surviving salt marshes (Burd 1989) are chiefly humans (farmers, salmon and elver fishermen, tourists) and stock put out to graze. The latter are overwhelmingly sheep and cattle, for the most part kept separate, but horses have been grazed locally. Farm dogs are occasionally seen. The few wild mammals that venture today on to the marshes and mudflats are mainly scavenging foxes.

(d) *Tracks in semi-liquid mud*

Semi-liquid mud in the inner Bristol Channel and Severn Estuary is distinguished by (a) its very high moisture content and very low yield strength, (b) the ease with which it wets and clings thickly to even greasy surfaces and, as a consequence of shear-thinning, (c) its ability when disturbed to flow and take a consistency ranging from thick paint to lumpy porridge. The semi-liquid state is the normal one of freshly deposited mud, but it is gradually lost, with a consequent gain in the strength of the sediment, due to the drainage and evaporation of pore water with increasing atmospheric exposure during low tide. Desiccation fractures are never seen. Tracks do not form in thick deposits of semi-liquid mud, which animals tend to shun, as they would otherwise become mired and flounder.

Figure 16*a* illustrates a typical track observed to have been made by a shod human in a thin (*ca.* 0.12 m) layer of semi-liquid mud overlying firm sediment at Hills Flats (ST 633978). Many fine laminae of silt and very fine sand were present in the affected deposit. The mud was extensively disrupted during the insertion of the foot and again, as the result of adhesion and suction, during its withdrawal. Deformation produced

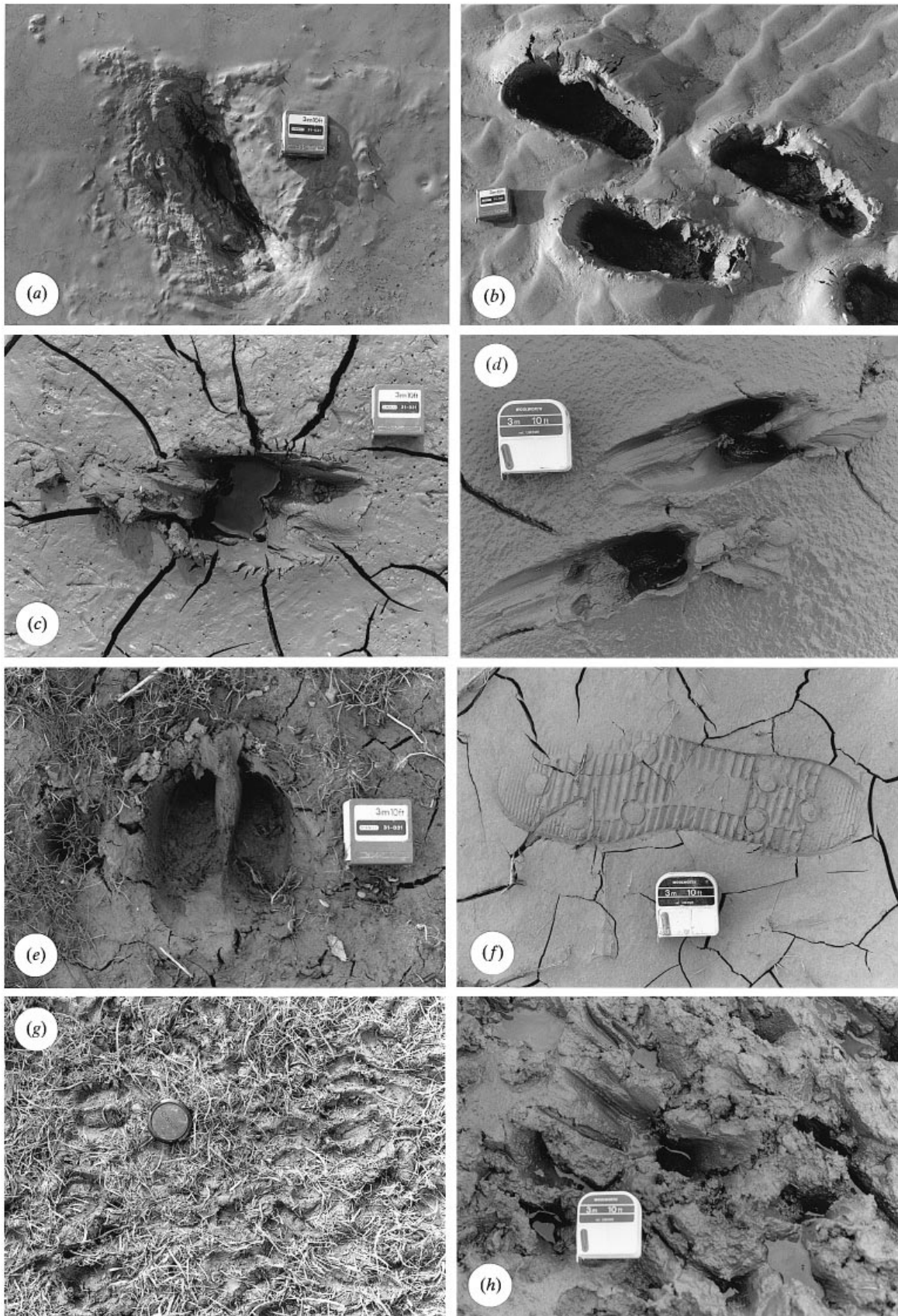

Figure 16. Field experiments on track-making. (a) Shod human in semi-liquid mud, Hills Flats (ST 633978). (b) Shod human in soft mud, Hills Flats (ST 632978). Note radial fractures. (c) Cattle in stiff mud, Oldbury Pill (ST 599929). Note radial deformation fractures, and that shaft has localized later desiccation cracks. (d) Sheep in stiff mud, Goldcliff (ST 363823). (e) Cattle and sheep in firm mud, St Pierre Pill (ST 521894). (f) Shod human in firm mud, Beachley Point (ST 551904). (g) Sheep trampling in stiff-firm mud, Wick St Lawrence (ST 359664). (h) Sheep trampling in soft mud, Goldcliff (ST 363823). Scales: tape boxes 50 mm square; lens cap 55 mm across.

a liquefied sediment, which consisted of a mixture of small, variously orientated 'rafts' of groups of undisturbed laminae (the lumps in the photograph) supported by a more homogeneous, fluid mud. No marginal fold survived. Instead, the deformed sediment collapsed and partly flowed back into the shaft, significantly narrowing and partly filling it and obscuring the footprint at the bottom. Marking the outer limit of the deformed zone were a few, short, circumferential tension fractures. Such a track, if fossilized, is unlikely to reveal much about the track-maker, and may be recognizable only as a mass of disrupted sediment below a slight depression on a bedding surface.

(e) Tracks in soft mud

Soft mud has a high moisture content and low yield strength, and adheres thickly to surfaces with which it is in contact. The tendency to flow and collapse, however, is much less pronounced than in the previous case, and is not always apparent. Desiccation fractures are never seen in soft muds.

Typical of tracks made in soft mud overlying firm are those produced at Hills Flats (ST 633978) by a shod human in a layer (*ca.* 0.1 m) of well-laminated mud above a firm deposit (figure 16*b*). The footprints are poorly formed and covered with many tall 'adhesion spikes', created as the foot was withdrawn. Each shaft is surrounded by a bold marginal ridge, cut by radial tension fractures; there is no sign that the sediment was liquefied as the result of deformation. The lips of the shafts carry a few blurred striae made by the foot, and the walls have collapsed (or been sucked) inward slightly. Tracks such as these could be infilled and preserved, but the footprints and overtraces are likely to show only the grosser anatomical features.

(f) Tracks in stiff mud

This material has a moderate moisture content and yield strength. It is readily moulded, securely retaining the shape given to it, but tends to adhere to surfaces, leaving behind local clusters of tiny spikes. Together with soft mud, it is perhaps the category of sediment in the Severn Estuary in which tracks are most commonly made. Some thick deposits of stiff mud may reveal widely spaced desiccation fractures, but most stiff muds lack these features. Once formed, however, tracks in stiff mud can serve to localize desiccation cracks that arise as the sediment loses further moisture.

Cattle and sheep were observed as they wandered over deep layers of stiff mud at, respectively, Oldbury Pill (ST 599929) and Goldcliff (ST 363823), photographs being taken either at the time (Goldcliff) or within a day or so (Oldbury Pill). The animals cut shafts of a depth similar to or slightly less than the diameter of the foot (figure 16*c, d*). The footprints were well defined and, in many cases, impressions of dewclaws appeared on a platform-like extension of a shaft. Marginal ridges were weakly developed and in some cases limited to only one side of the shaft; vertical radial fractures accompanied only the more strongly

developed ones (figure 16*c*). Striated ejecta, mostly attached to the inner lip of the shaft, were associated with both the sheep and cattle tracks, but only the sheep spoor included finely grooved drag marks. Fossilized tracks such as these are likely to preserve substantial anatomical detail, in the form of undertraces, the footprints themselves, and overtraces.

(g) Tracks in firm and hard mud

These two categories of material are distinguished by their high yield strength and, respectively, their low and negligible moisture contents. Hard mud, normally encountered on salt marshes only during summer months, is so dry and strong that an animal leaves no trace behind, other than powdery scuff marks or a few broken and displaced mud flakes where desiccation fractures had developed horizontally along laminae in the sediment (Allen 1987*a*). However, on the fringes of salt marshes and in the creeks, a thin surface layer of hard mud is commonly found to overlie a thick layer of stiff or even soft sediment. Tracks made under these circumstances consist merely of more or less deep shafts, at the bottoms of which are plates of mud which have been pressed down from the surface but are devoid of footprints.

Firm mud retains sufficient moisture that it can just be moulded in the hand but without adhering; such muds frequently reveal desiccation fractures in an early stage of growth. The feet of animals seen crossing surfaces of firm mud at St Pierre Pill (ST 521894) and Beachley Point (ST 551904) sank to depths of no more than a few millimetres or centimetres, leaving undistorted and sharply defined footprints unaccompanied by either collapsed shaft walls, significant marginal ridges or ejecta (figure 16*e, f*). A short sequence of high-fidelity undertraces may be expected to underlie each footprint, and there is the potential for a sequence of high-fidelity overtraces to accumulate directly above in the shaft. The footprint itself should preserve the finest anatomical detail. Dinosaur footprints with the impressions of tuberculate skin, for example, seem to have been made in a muddy substrate that was firm (Currie *et al.* 1991).

(h) Trampled surfaces

Animals are seen to continually wander over a grazing marsh with only sparsely distributed or already close-cropped vegetation, as at Wick St Lawrence (ST 359664) and Goldcliff (ST 363823). The observed result is a more or less densely trampled surface, on which the tracks vary in spacing from a few diameters apart to overlapping, together with a more or less intensely reworked superficial deposit of a thickness increasing as the strength of the sediment declines and the animals sink more deeply and frequently (figure 16*g, h*). These observations suggest that, in a fossil context, the track-maker(s) may be difficult to identify, since all but the youngest spoor are likely to have been modified by subsequent trampling. Given the quantity of skeletal remains and tracks in the associated sediments, Laury (1980) considered it likely that

mammoths trampling the laminated mud at the bottom of a shallow, sinkhole pond were responsible for the almost complete destratification of much of the deposit that was present.

(i) *Contemporaneity of tracks with sedimentation*

In areas like the Severn Estuary, where mammals living today can in many places walk over exposures of Flandrian deposits that contain tracks due to their subfossil counterparts, it is important to be able to demonstrate that the tracks observed are truly contemporaneous with the sediments in which they occur. Since the deposits are unlithified, the tracks could have been made by modern animals as they traversed the eroding outcrops. The following criteria, especially if applied collectively, have been found helpful in distinguishing contemporaneous from contemporary tracks.

Tracks and trackways contemporaneous with sedimentation are generally restricted to particular bedding surfaces and, for a given quality of preservation, normally do not step up or down from one surface to another. They can also be traced laterally by excavation into the outcrop of the sediment, where they lie partly to fully concealed. Thirdly, contemporaneous tracks, like the sediments lateral to them, commonly are pierced by plant root-channels or by the burrows or siphon tubes, with diagenetically hardened walls, of infaunal invertebrates.

6. DISTRIBUTION AND PRESERVATION OF SUBFOSSIL TRACKS

(a) *Review of late Quaternary stratigraphy*

The Flandrian deposits in the inner Bristol Channel and Severn Estuary from which mammalian tracks have been recorded form part of a complex sequence of late Quaternary sediments, laid down in various terrestrial and marine environments over a period of profound and linked changes in climate and relative sea level.

These sediments are associated with a dissected bedrock surface taking the form of 'valleys within a valley' (figure 17*a*). The inner valleys seem to have contained the rivers of the area at times of glacial low-stand of the sea (Codrington 1898; Leese & Vernon 1960; Hawkins 1962; Anderson & Blundell 1965; Anderson 1968, 1974; Williams 1968; Gilbertson & Hawkins 1978; Whittaker & Green 1983; Allen 1987*e*). The outer valley has a relatively level floor, the higher parts of which appear intertidally as rock platforms (e.g. Hills Flats, Oldbury Flats, English Stones) and even as a variety of islands (e.g. Aust, Goldcliff, Flat Holm). This surface and its outer margins have been shaped by several processes. Interglacial (?Ipswichian) beach deposits occur along the northern margin (Locke 1970–71; Andrews *et al.* 1984) and are visible at Goldcliff, on the shores of an island. At Goldcliff, the deposits are succeeded by a periglacial head (?late Devensian) with involutions and possible ice-wedge casts. Head deposits abound along the southern and eastern margins of the outer valley (Welch & Trotter 1961; Gilbertson & Hawkins 1978, 1983) and ice-

wedge casts (?late Devensian) are widely known from its floor (Allen 1984, 1987*e*). Later Pleistocene fluvial terrace deposits crop out intermittently along the edges of the outer valley, including the 'Main Terrace' near the level of present-day high tides (Wills 1938; Hey 1991; Maddy *et al.* 1995).

The subsequent Flandrian deposits were laid down on mudflats and salt marshes at the margins of the estuary during a period of warming and rapidly rising relative sea level (Heyworth & Kidston 1982). Data on these sediments are scattered and a systematic treatment remains to be attempted, despite the availability of exceptionally fine intertidal exposures and many boreholes. However, a 'standard' stratigraphy can be pieced together, which is recognizable throughout the outer valley (figure 17*a*). Named for the Wentlooge Level in Gwent (Allen & Rae 1987), the Wentlooge Formation (*ca.* 10–15 m thick) may be divided informally into three parts. Typically, the lower Wentlooge Formation consists of a basal peat, locally replaced by gravels and sands, overlain by several to many metres of high-intertidal silts which in places include root beds and thin, impersistent peats. Infilled palaeochannels, presumed to record networks of tidal creeks that wander through the marshes and flats, are widely present in these sediments. The middle Wentlooge Formation is characterized by a number of high-intertidal silts and and partly supratidal, laterally extensive peats intercalated on a decimetre to metre scale, the peats thickening and fusing landward toward bedrock 'islands' and the outer margins of the outcrop. Relative sea level fluctuated markedly, while continuing its underlying upward trend, during the period represented by the middle division. Palaeochannels are again present, but the field evidence shows that the creek networks had generally become infilled by the time a peat had formed; with the return of silt, however, new patterns of tidal channel developed. A return to thick, high-intertidal silts is evident in the upper Wentlooge Formation. The main stratigraphical variations seen in the Wentlooge Formation are in terms of the overall thickness and the completeness of the lower member, and the number and thickness of the peats recognizable at any one locality. Regionally, the sequence thins up-estuary and toward the edges of the outer valley; local variations are related to undulations, and especially small, tributary valleys, on the bedrock floor.

The Wentlooge Formation is widely recorded from the southern margins of the inner Bristol Channel and outer estuary (Godwin-Austen 1865; Godwin 1948; Beckinsale & Richardson 1964; Green & Welch 1965; Hawkins 1968; Jefferies *et al.* 1968; Kidson & Heyworth 1976; Gilbertson & Hawkins 1978; Whittaker & Green 1983; Edmonds & Williams 1985; Burton & Hodgson 1987; Gilbertson *et al.* 1990; Kellaway & Welch 1993), and there are scattered reports from the northern side (Strahan 1896; Hyde 1936; Seddon 1964; Squirrel & Downing 1969; Locke 1970–71; Murray & Hawkins 1976; Burton & Hodgson 1987; Waters & Lawrence 1987; Smith & Morgan 1989; Allen & Rippon 1997). Records of the Wentlooge Formation are less plentiful from the middle

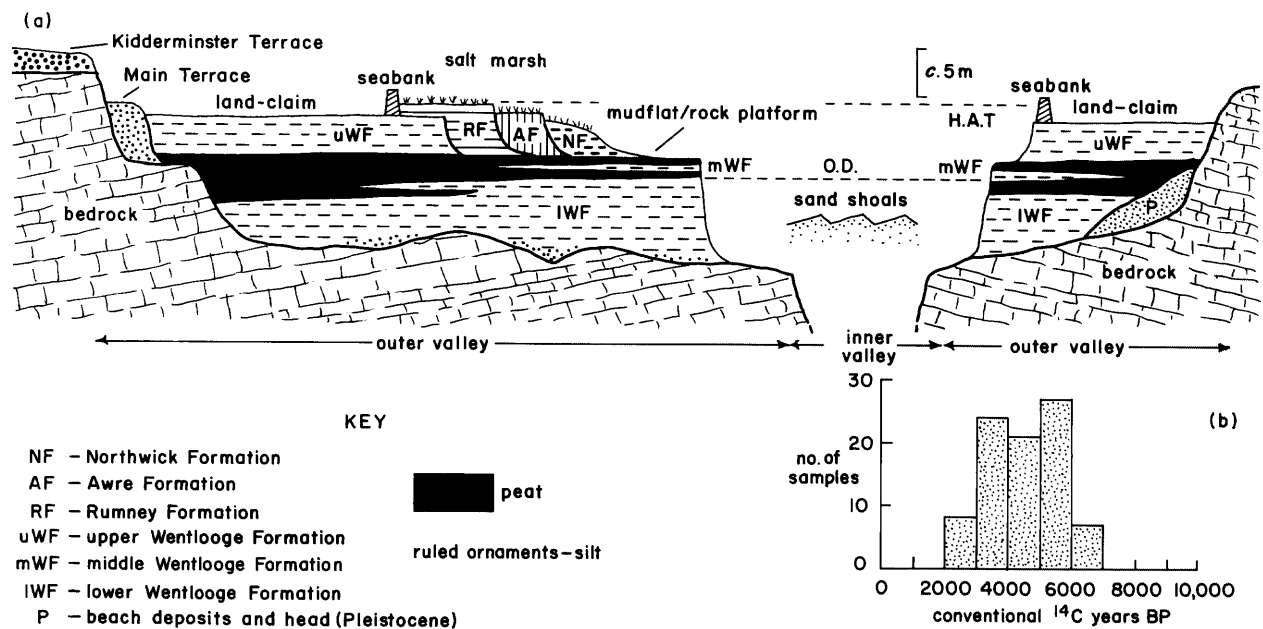

Figure 17. Late Quaternary stratigraphy of the inner Bristol Channel and Severn Estuary. (a) Schematic cross-section across the waterway, with the Flandrian sequence (Wentlooge, Rumney, Awre and Northwick Formations) approximately to scale and shown relative to Ordnance Datum (O.D.) and the level of the Highest Astronomical Tide (H.A.T.). The bedrock is mainly Trias but locally is formed of other rocks. (b) Frequency distribution of 87 conventional radiocarbon dates from intercalated peats in the Flandrian of the area (see text for details of sources).

estuary (Lucy 1877; Welch & Trotter 1961; Beckinsale & Richardson 1964; Murray & Hawkins 1976; Cave 1977; Allen & Fulford 1987, 1996; Hewlett & Birnie 1996). A feature of these records is a north-easterly rise of the base of the Wentlooge Formation, expressed as a thinning of the lower member. In a continuation of this trend, the lower member is absent at many places in the inner estuary, intercalated peats and silts lying directly on either gravel or bedrock (Prevost *et al.* 1901; Beckinsale & Richardson 1964; Worssam *et al.* 1989; Hewlett & Birnie 1996).

Evidence for the age of the Wentlooge Formation comes chiefly from the middle division. A total of 87 radiocarbon dates on peat or wood (figure 17b) shows that this member spans a period of about 3500 years (Godwin & Willis 1964; Hawkins 1971; Murray & Hawkins 1976; Heyworth & Kidson 1982; Allen & Rae 1987; Smith & Morgan 1989; Allen & Fulford 1992, 1996; Aldhouse-Green *et al.* 1992; Barnes *et al.* 1993; Bell 1993, 1995; Walker & James 1993; Scaife & Long 1995; Allen 1997a; Allen & Rippon 1997). Deposition of the intercalated peats began between 6660 and 6052 conventional radiocarbon years BP (mean 6262 years) and finished between 2890 and 2180 years (mean 2603 years), the one-sigma laboratory error on these dates generally being of the order of 50 years. Hence the Neolithic and the Bronze Age are covered in their entirety, together with the earlier Iron Age, periods during which the estuarine area was undoubtedly exploited by humans, with settlement taking place on the wetlands especially during those times when peat marshes were beginning to be replaced by mineralogenic marshes. However, because of the way the middle division is defined lithologically, the bounding dates are subject to local variation.

Post-Roman instability of the shoreline is expressed on the mudflats and salt marshes by three, erosively-based, offlapping morphostratigraphic elements (figure 17a). The oldest of these is the Rumney Formation. As originally defined and dated, the Rumney Formation consists of pale brown silts passing up into grey silts that began, on ceramic grounds, to form from the late seventeenth century (Allen 1987d; Allen & Rae 1987; Allen, 1997b). Recently, erosively based units of pale brown silts apparently of medieval inception have been recognized locally beneath the original Rumney Formation, as at Frampton-on-Severn and Pill House, Tidenham. Accordingly, the term Rumney Formation is here extended to cover both bodies of pale brown silt, as well as brown silts of young but uncertain date, the qualifier 'lower' or 'upper' being applied where the evidence allows an element to be separately identified. The Awre Formation of Allen & Rae (1987) is a unit composed of grey silts that began to be deposited in the late nineteenth century. It was not until the second or third quarter of the twentieth century that the succeeding grey silts of the Northwick Formation began to form (Allen & Rae 1987). All three formations are represented throughout the area, locally reaching a thickness of several metres. As the youngest unit, least affected by erosional tendencies, the Northwick Formation is especially widespread.

(b) Mammalian fauna

Judged from Stuart's (1982) national review, a wide variety of large mammals could at times have left tracks and trackways in the Flandrian sediments formed on the margins of the inner Bristol Channel and

Severn Estuary. Among the native herbivores are wild horse (*Equus ferus*), elk (*Alces alces*), wild boar (*Sus scrofa*), red deer (*Cervus elaphus*), roe deer (*Capreolus capreolus*) and aurochs (*Bos primigenius*). Alien introductions include domestic sheep (*Ovis*) and goats (*Capra*), dating from the Neolithic onward, and the domestic horse, dating from the Bronze Age. Domestic cattle and pig probably developed from indigenous wild forms. The main carnivores are wolf (*Canis lupus*), fox (*Vulpes vulpes*), brown bear (*Ursus arctos*) and wild cat (*Felis sylvestris*). A wide range of habitats, although not necessarily all at the same time, was available for these animals on the margins of the Severn Estuary and inner Bristol Channel, including lowland forest, fen carr, open salt marsh and mudflat-fringe. The latter could have been especially appealing during the summer, when low tides allow efflorescing sea salt to be licked from drying mud.

Although systematic work is lacking in the Severn Estuary and inner Bristol Channel, and reliance has to be placed on largely isolated, casual finds, many elements in Stuart's (1982) faunal list have already been recognized as skeletal remains, albeit very few and scattered. Aurochs are reported from the lower Wentlooge Formation of the Wentlooge Level (Green 1989), and boar, red deer, wolf/dog, fox and cat are recognized from the Mesolithic, estuary-margin site at Goldcliff on the Caldicot Level (Parkhouse 1991). The middle Wentlooge Formation, ranging into the earlier Iron Age, has yielded horse, boar, red deer, roe deer, cattle, sheep/goat and dog at localities dispersed throughout the area (Lucy 1877; Prevost *et al.* 1901; Whittle *et al.* 1989; Allen & Fulford 1992; Nayling 1992; Allen 1997a). Within the limits of the scant remains, red deer seem to have been especially widespread and plentiful at this time. Skeletal material preserved in the less well-exposed, upper Wentlooge Formation is best known from Iron Age and Romano-British archaeological contexts in the deposits. The fauna includes horse, pig, cattle, sheep and dog (Whittle *et al.* 1989; Allen & Fulford 1992; Fulford *et al.* 1994). The limited record of red deer probably reflects the dominance of domesticated animals in these assemblages. Skeletal remains are practically unknown from the post-Roman deposits. At Magor Pill, however, the Rumney Formation, infilling a large palaeochannel, preserves the bones and teeth of cattle, horse and sheep, evidence of medieval–early-modern exports of store cattle from Wales to England (Allen & Rippon 1997).

The recognition of the presence and behaviour of these animals from their tracks in the sediments has been facilitated by (a) comparison with spoor personally observed to have been made by contemporary animals (see above), (b) reference to the experimental results (see above), which allowed largely concealed tracks to be located and excavated, and undertraces and overtraces to be distinguished and their quality assessed, and (c) the many European and North American books on vertebrate footprints and signs, ranging from the popular to the forensic (Jaeger 1948; Murie 1954; Leutscher 1960; Ennion & Tinbergen 1967; Lawrence & Brown 1973; Bang & Dahlstrom

1974; Falkus 1978; Bouchner 1982; Robbins 1985). For the larger mammals, the works of Leutscher and of Lawrence & Brown are especially helpful; Robbins discusses human tracks from a chiefly forensic standpoint. Whatever the source of comparative information, identification in the field was based on the size and shape of the overtrace, footprint or undertrace as a whole and also of its elements. The large mammals definitely recognized so far from tracks in the Flandrian deposits are humans, cattle, sheep/goat and deer. There are indications of horse and possibly wolf/dog.

(c) Lower Wentlooge Formation (figure 18a)

The lower Wentlooge Formation, cropping out intertidally below the peat ledges created by the middle division, is poorly exposed and best seen in the outer estuary.

Ill-preserved human tracks with those of deer occur at Goldcliff (ST 376819) in well-laminated silts below the main (lowermost) peat. Aldhouse-Green *et al.* (1992) describe from Uskmouth (ST 337819) the main display of human spoor at this general stratigraphic level (figure 19a). Three lengthy trackways made by two unshod, probably adult males, and a young person or child were found exposed over extensive, stratigraphically close bedding surfaces in well-laminated silts. The people were proceeding in a direction oblique to the present shoreline. One track, contained in an excavated block of silt, was examined by X-raying thin slices (see Allen *in* Aldhouse-Green *et al.* (1992)). The shaft is only 40–60 mm deep, suggesting that the trodden substrate was a stiff, bordering on firm, mud at the time. Associated with the weak marginal upfold are normal and reverse microfaults, suggesting the presence of a 'dead' region. As the laminae which form the undertraces are severely thinned and buckled, the mud at a shallow depth was probably even stronger than that at the surface. The buckles have some resemblance to Kidan & Cosgrove's (1996) 'pinch-and-swell' structures. Short trackways made by adults and juveniles were recorded near Redwick on the Caldicot Level (ST 426838).

Cattle tracks, presumably those of aurochs, are recorded only from Uskmouth (ST 330818–337819), Redwick (ST 421835) and Magor (ST 4328412–438845), at all of which they occur in association with the generally much more plentiful spoor of deer at a number of stratigraphic levels (figure 20a). The affected silts are laminated and the character of the tracks suggests that the sediment was stiff to firm. The Redwick tracks are part of a trampled area several tens of square metres in extent (figure 21), apparently beside a palaeochannel. From the 'lower blue clay' at Magor, Mr Derek Upton of Caldicot (*personal communication*, 1987) recorded a number of undertraces of what are here interpreted as wolf/dog.

Red deer are well represented at several localities by tracks in laminated silts of the division. Especially fine displays occur along the shore at Uskmouth (ST 330818–337819), where extensive bedding surfaces reveal areas of moderate to dense trampling, inter-

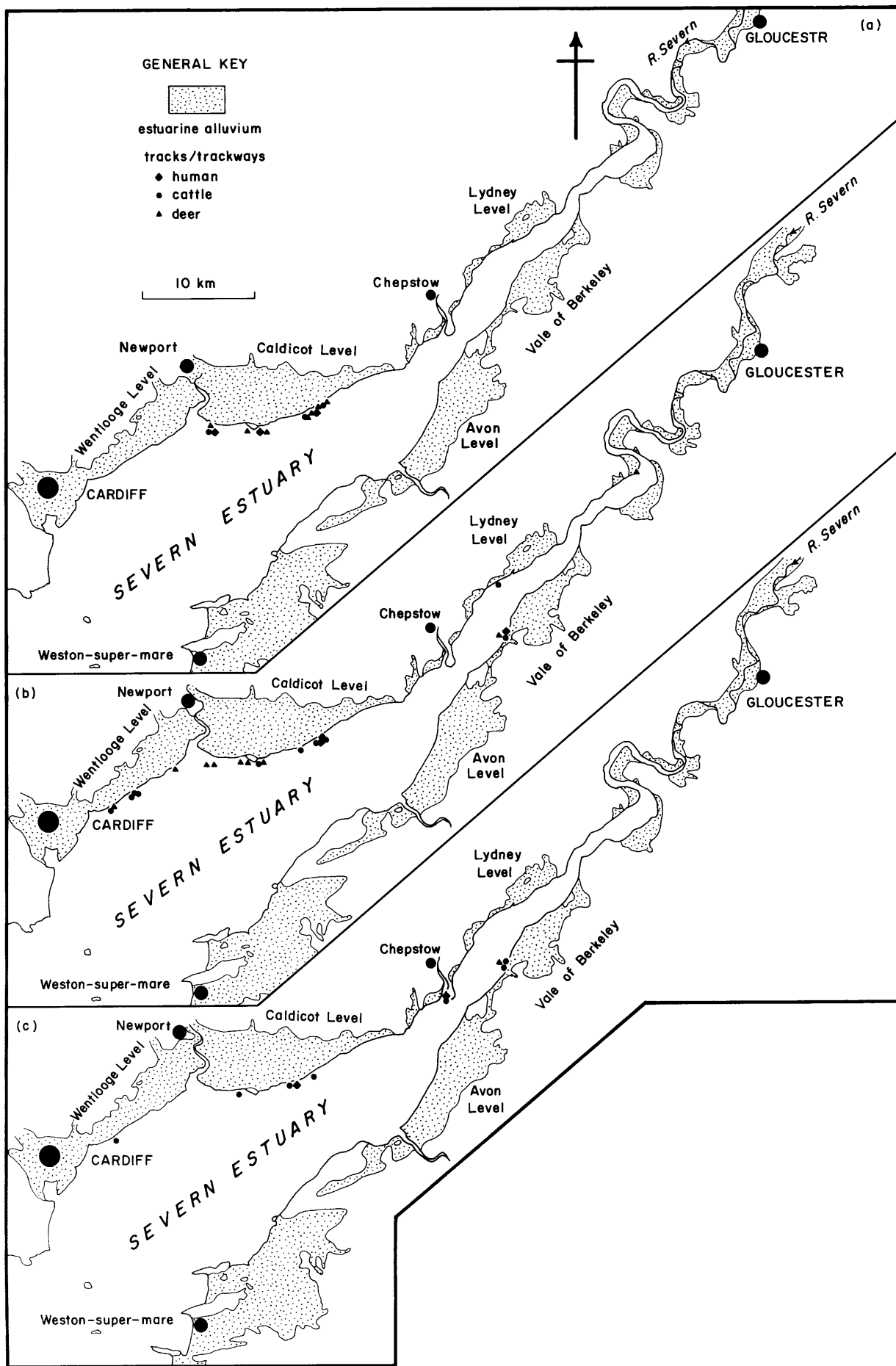

Figure 18. For description see opposite.

secting trackways and isolated tracks (figure 22*a*), and again in the extensive trampled area at Redwick (figure 21). At both places, the tracks were made in sediments that varied at the time from stiff to firm.

(d) Middle Wentlooge Formation (figure 18*b*)

The middle division is the best and most extensively exposed part of the Wentlooge Formation, with representatives throughout the area.

Human tracks are recorded from three localities. The upper surface of a Neolithic occupation deposit immediately overlain by estuarine silt at Oldbury Flats (ST 632978) was deeply and intensely trampled by some humans and probably deer. From a bedding surface exposed south-west of Magor Pill (ST 433843), Aldhouse-Green *et al.* (1992) described a short trackway of an unshod, adult male, together with other tracks, including that of possibly a child. They were also travelling obliquely across the shore and, it can be seen in the field, toward a large, tidal palaeochannel that crossed the coast almost at right angles. Nearby, a human trackway, and that of possibly a dog, was found among laminated silts contributing to the fill of another palaeochannel.

Poorly preserved cattle tracks appear at many places on the Gwent coast. Here they are associated with deer and possibly horse spoor on the trampled floors and margins of small channels developed contemporaneously with the growth of peat marshes. The tops of the peats at Oldbury Flats are trampled here and there, and locally (ST 601935) cattle spoor occur in the laminated silts between the beds (figure 20*b*).

The tracks of probably red deer are known from localities dispersed over the entire estuary. The animals occasionally crossed the peat marshes, where their tracks, infilled with organic-rich silt, are preserved mainly at the tops of the intercalated peats, but they chiefly trampled the floors and margins of the shallow creeks that meandered through those marshes, perhaps finding these features convenient as routeways. Locally, tracks are seen in the laminated silts of the division, as at Goldcliff (ST 362820–369819). Here there are extensive areas of trampling, in sediments that were mainly stiff (figure 22*b*), and further examples of trackways and isolated spoor (figure 22*c*). At Oldbury Flats (ST 599932, 601935), where the peats yield red deer antlers and bones, trackways of the walking animals mark the tops of the peats and are plentiful in the intercalated silts (figure 22*d*).

(e) Upper Wentlooge Formation (figure 18*c*)

This division is rarely seen, largely because it is obscured by sea defences in the outer estuary and inner Bristol Channel and, in the middle and inner estuary, is replaced by Rumney, Awre and Northwick deposits.

Trackway records of humans are sparse. At Redwick (ST 413831), green silts smother the densely trampled bottom of a small, shallow channel eroded into a thick peat; human tracks are present, together with cattle and possibly horse. Ill-preserved human tracks were seen at Beachley (ST 543909) on a bedding surface that also showed widely spaced but narrow, contemporaneous desiccation cracks of a type restricted to the mudflat–salt marsh fringe (Allen 1987*a*).

There are more records of cattle. They trampled the soft muds forming within erosional palaeochannels at Rumney Great Wharf (ST 249778) and Redwick (ST 413831, 428840) and, at Beachley (ST 543909) and Oldbury Flats (ST 601935), walked over surfaces of firm, laminated mud (figure 20*c*). Intense trampling by cattle, accompanied by possible horse, is recorded by Bell (1995) from the floor of a complex palaeochannel apparently eroded into the top of the main peat at Goldcliff (ST 357820). At Oldbury Flats, (?red) deer seem also to have been present.

(f) Rumney Formation (figure 23*a*)

The Rumney Formation is best developed in the middle and inner Severn Estuary and is rarely seen in the outer estuary and inner Bristol Channel.

Human spoor occur abundantly in the upper Rumney Formation exposed intertidally at Pill House, Tidenham (ST 568958), and Plusterwine, Woolaston (ST 604990). At Pill House short human trackways and areas of trampling are intermingled with those of cattle and sheep, the character of the tracks suggesting semi-liquid to soft mud (figure 19*b*). They are exposed on long bedding surfaces that slope moderately steeply down into the estuary, a little above an erosional surface strewn with seventeenth-century pottery and other debris (Allen & Fulford 1987, bed B). A line of stepping stones is also present, and nearby lies a setting of decayed, stout timbers, suggestive of a small jetty. The occurrence at Plusterwine also suggests animal-handling, either into boats or at one end of a low-tide ford across the sandflats and shallow channels of the estuary (2.3 km wide). Many long trackways of mainly unshod humans and cattle can be traced for tens of metres down gently sloping bedding surfaces toward low water. The mud was semi-liquid to soft, for the shafts are generally deep and with collapsed sides (figure 19*c*). The trackways seem to emanate from a paved drove now seen at a depth of up to 2.5 m in the Rumney Formation. Accompanying the various surfacing materials opportunistically used—brick, tile, stone, roundwood cordons, bundles of furze—are small amounts of pottery and industrial residues (blast-furnace tap slag; copper-smelting tap slag and cast building blocks) of the later eighteenth century, which date the tracks.

Figure 18. Distribution of the tracks/trackways of the larger large mammals in Flandrian (before *ca.* 1900 years BP) mudflat–salt marsh deposits of the Severn Estuary. (*a*) lower Wentlooge Formation. (*b*) middle Wentlooge Formation. (*c*) upper Wentlooge Formation.

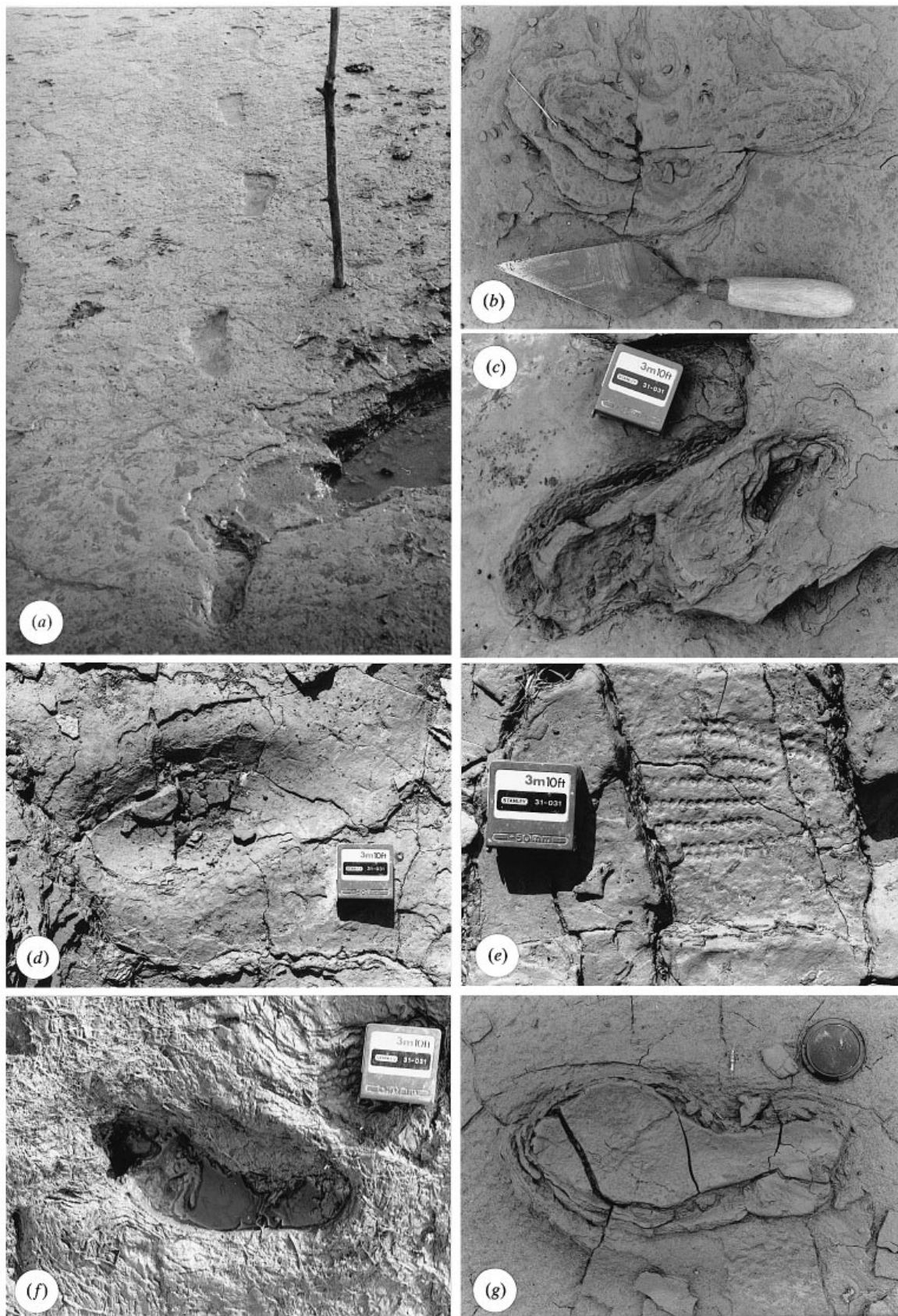

Figure 19. Human tracks. (a) lower Wentlooge Formation, Uskmouth (ST 337819) (photograph Derek Upton). (b) upper Rumney Formation, Tidenham (ST 568958). (c) Rumney Formation, Plusterwine (ST 604990). (d, e) Awre Formation, Frampton-on-Severn. (f) Northwick Formation, Tites Point (ST 90047). (g) Northwick Formation, Strand (SO 709135). Scales: stick *ca.* 0.8 m tall; tape box 50 mm square; lens cap 55 mm across; trowel 0.28 m long.

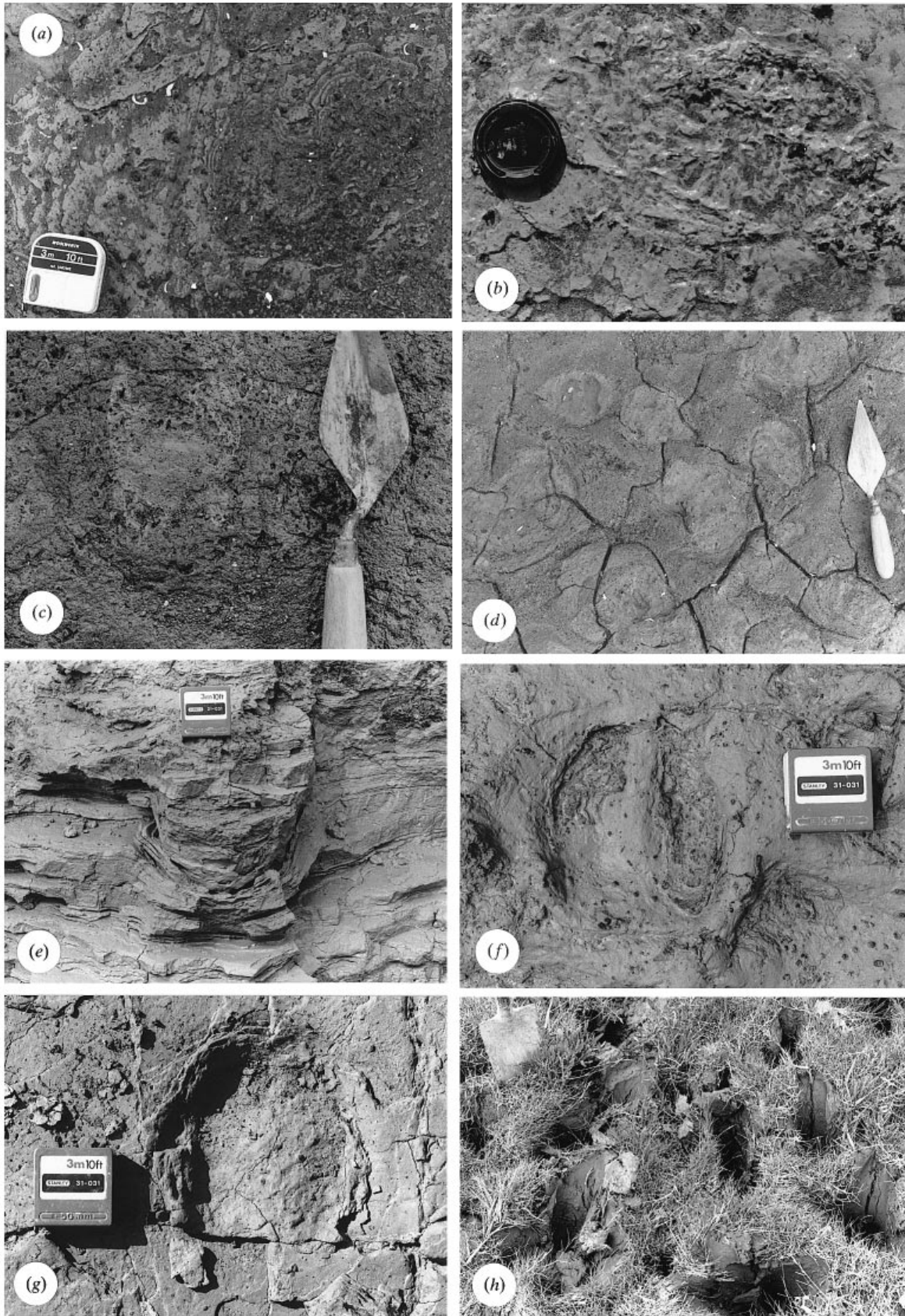

Figure 20. Cattle tracks. (a) lower Wentlooge Formation, Magor Pill (ST 438845). (b) middle Wentlooge Formation, Oldbury Flats (ST 601935). (c) upper Wentlooge Formation, Oldbury Flats (ST 601935). (d) Base of Upper Rumney Formation, Rumney Great Wharf (ST 240779). (e) Deformed zone and shaft-fill, Rumney Formation, Plusterwine (ST 604990). (f) Rumney Formation, Plusterwine (ST 604990). (g) Awre Formation, Frampton-on-Severn (SO 736086). (h) Trampled surface, Northwick Formation, Woolaston (ST 602986). Scales: tape boxes 50 mm square; lens cap 55 mm across; trowel blade 74 mm wide; spade blade 0.135 m wide.

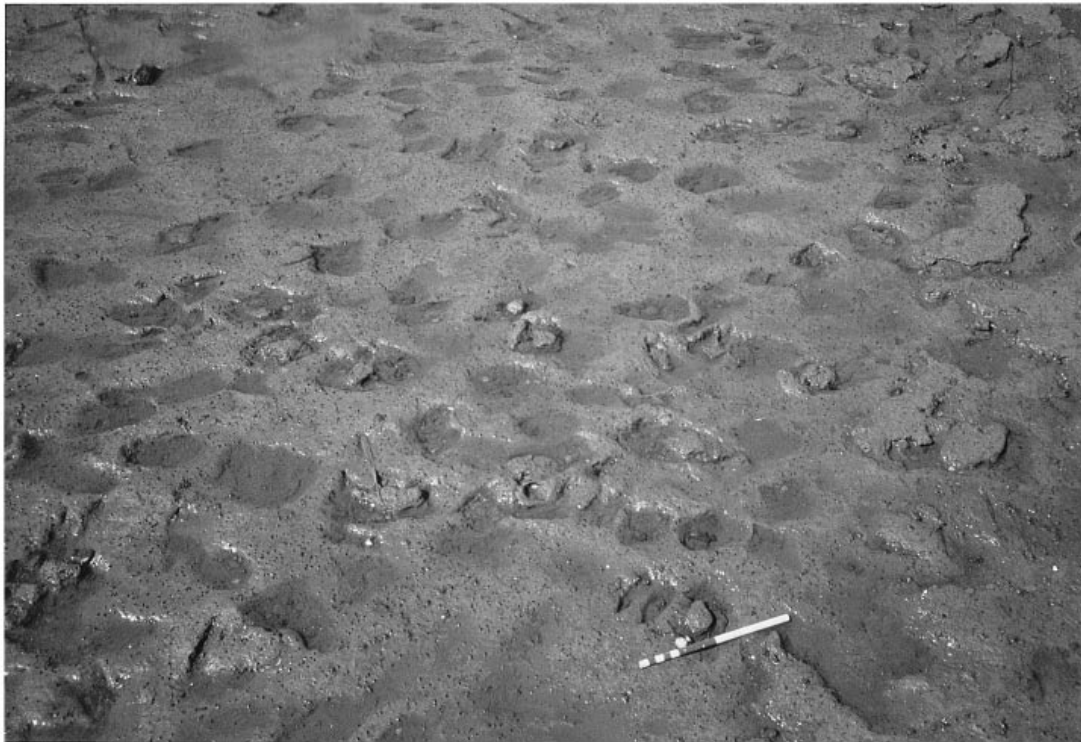

Figure 21. Part of an extensive surface of laminated silt trampled by red deer and a few cattle, lower Wentlooge Formation, Redwick (ST 421835). Scale is 0.2 m long.

The many occurrences of cattle spoor point to widespread grazing on the marshes with associated mudflats, beneath which accumulated the Rumney Formation. Apparently the oldest examples, assigned to the lower member, occur at Frampton-on-Severn (SO 737067–736087) at several levels beneath a buried soil with medieval ridge-and-furrow (Allen 1986, 1988). The character of the tracks suggests that sediment conditions ranged from soft to firm. From the base upward in the upper member, the tracks are especially plentiful and well-preserved at Rumney Great Wharf (ST 235777–252788), Oldbury Pill (ST 600928–601935), Pill House (ST 568958–569961), Horse Pill (ST 580973–583974), Plusterwine (SO 604990) and Awre (SO 714077). Mud conditions again were variable. At Rumney Great Wharf, where most shafts are very shallow, there was locally (e.g. ST 240779) much trampling (figure 20*d*). The tracks at Plusterwine are displayed in various ways, from vertically as deep, infilled shafts with marginal and axial folds (figure 20*e*) to transversely as the shallowest of undertraces (figure 20*f*).

Although sheep and goat were domesticated from Neolithic times onward (Stuart 1982), their tracks are rare and have yet to be found in deposits older than the Rumney Formation. The only record of sheep/goat from the lower member is an extensive, lightly to densely trampled surface (figure 22*e,f*) lying 0.75 m below the buried soil with ridge-and-furrow at Frampton-on-Severn (SO 738081). The sediment which received the footprints appears to have been very stiff or firm. The tracks of sheep are subordinate to those of those of cattle in the basal beds of the upper Rumney Formation at Rumney Great Wharf (ST 240779) and at Pill House (ST 568958).

(g) *Awre Formation* (figure 23*b*)

Although represented throughout the area, human tracks were found in the Awre Formation only at Frampton-on-Severn (SO 737067–736087), where up to 1.6 m of silt accumulated after set-back on a 2 km frontage in the third quarter of the nineteenth century (Allen 1986, 1988). The lower and more rapidly accumulated part of the deposit in many places includes deep shafts accompanied by strong downfolds and marginal upfolds (figure 19*d*). At a middle level occurs a short trackway made in very stiff mud by a walker in hob-nailed boots (figure 19*e*).

Cattle tracks have a distribution and preservation similar to that in the Rumney Formation, the best examples occurring in the middle and inner estuary in well-laminated silts at Horse Pill (ST 580973–583975), Frampton-on-Severn (SO 737067–736087), Awre (SO 705079–708075) and Rodley (SO 754108). The prevalence of deep shafts and strongly developed axial downfolds, affording long sequences of undertraces (figure 20*g*), suggests sediment conditions of mainly soft to moderately stiff mud.

Sheep are grazed on a number of salt marshes in the Severn Estuary, but only near Tites Point (SO 703042) have their tracks been identified in the Awre Formation.

(h) *Northwick Formation* (figure 23*c*)

The Northwick Formation is the youngest and most widespread of the post-Roman silt deposits in the high intertidal zone.

Human trackways occur at Tites Point (SO 690047), in the middle estuary, and in the inner estuary at

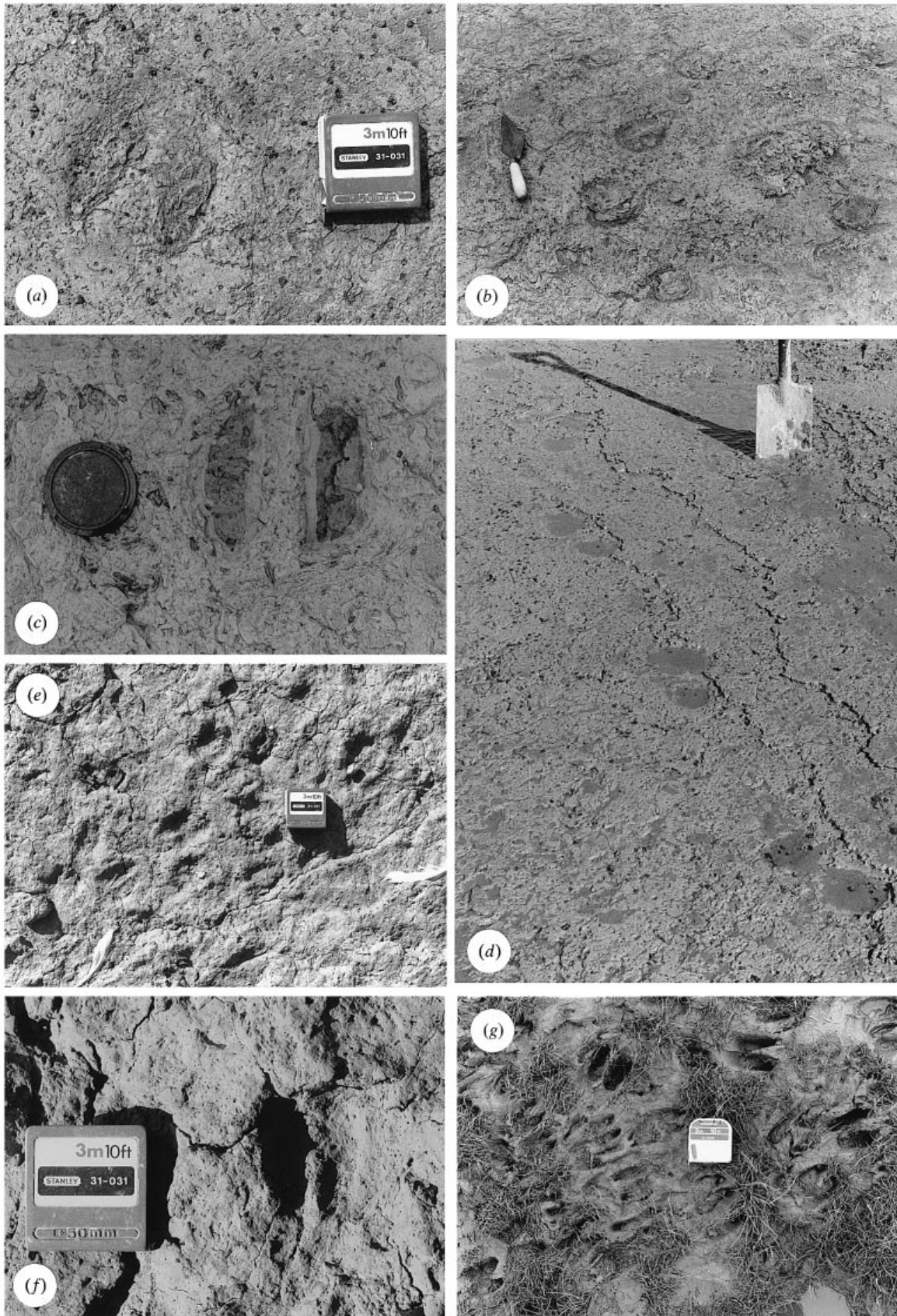

Figure 22. Deer and sheep/goat tracks. (a) lower Wentlooge Formation, Uskmouth (ST 330818). (b) Deer (smaller tracks) and cattle (larger tracks), middle Wentlooge Formation, Goldcliff (ST 368818). (c) Deer with toes splayed apart, middle Wentlooge Formation, Goldcliff (ST 362820). (d) Deer trackway, Oldbury Flats, middle Wentlooge Formation (SO 599932). (e) Trampling by sheep/goat, lower Rumney Formation, Frampton-on-Severn (SO 738081). (f) Detail of (e). (g) Trampling by sheep, Northwick Formation, Goldcliff (ST 363823). Scales: tape boxes 50 mm square; lens cap 55 mm across; spade blade 0.135 m wide.

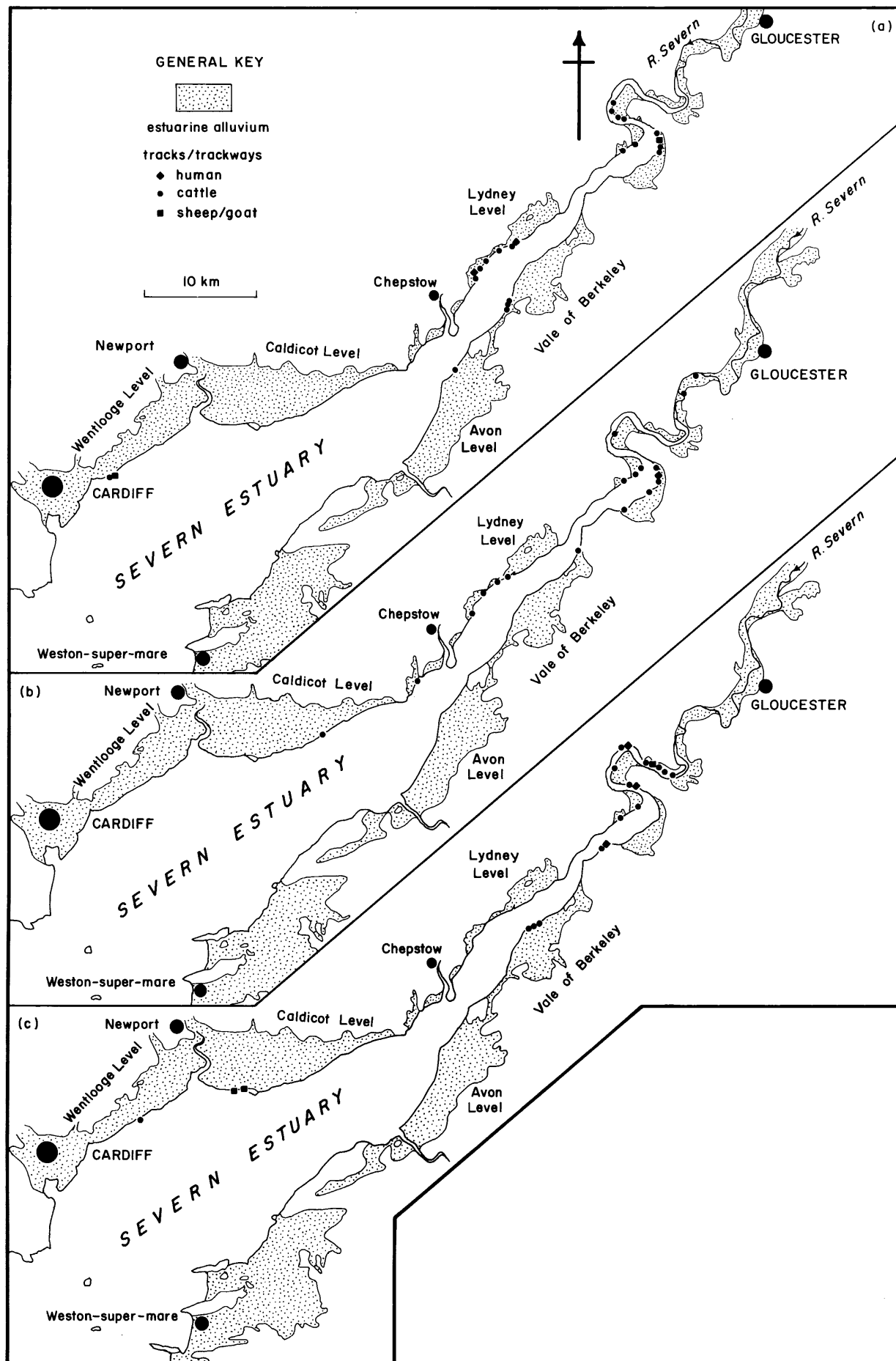

Figure 23. For description see opposite.

Arlingham (SO 714098) and Strand (SO 709135). Deep shafts, modified and freed of their contents by erosion, are preserved at Tites Point; the juvenile maker was barefoot and walked through soft mud (figure 19*f*). At Strand, a trackway was made in moderately stiff mud, modified by erosion, buried so that overtraces built up in what survived of the shaft, and then eroded a further time (figure 19*g*).

Although widespread and abundant, cattle tracks are seldom well preserved in this rapidly accumulating body of generally weak mud. The intense reworking of the surface sediment by trampling cattle is ruled out only by long periods of weak tides and dry weather during the summer. Closely spaced shafts up to 0.35 m deep with slightly indrawn walls result from trampling (figure 20*h*). Their sides fracture as the mud gradually dries, and they become infilled episodically with overtraces as successive spring tides attain their level.

The most informative of these tracks lie in the seasonally banded, well-laminated, sandy silts exposed in the inner estuary at Rodley (SO 721123–745107), where serial sectioning is possible and successful peels can be made. Figure 24*a–e* gives a sequence of internal-vertical sections representing sediment conditions which ranged from a thin, soft layer above a stiff-firm one, to a deep soft-stiff deposit. Marginal upfolds are well developed and tend to be box-shaped in vertical section. Layer-thinning is especially severe where a soft, thin surface layer overlays stiff-firm sediment, and the presence of a *décollement*, or layer-parallel glide surface, beneath the upfold may be suspected (figure 24*a, f*). *Décollement* seems also to have occurred at the bases of groups of muddier laminae that were intersected by the foot (figure 24*d*). Axial downfolds and undertraces are best developed where soft-stiff mud was pierced (figure 24*e*), and may be accompanied by axially-dipping microfaults (figure 24*a, d, e, g*), suggesting that a ‘dead’ region formed beneath the hooves. Cross-folds appear beneath the interdigital clefts (figure 24*b, d*). The shafts were infilled in various ways. In some cases (e.g. figure 24*b*), the soft layer seems to have collapsed into the shaft, with the accompaniment of some internal brecciation, before suffering erosion. The shaft in figure 24*d* was partly filled in this way, but was finally sealed by a set of overtraces which record only the general outline of the shaft but no other anatomical details. Sandy overtraces that dip and thicken into the shaft rapidly buried the track in figure 23*c*. Such overtraces have a concentric ‘outcrop’ in transverse section; the example in figure 23*h* is from a sufficiently high level to preserve, external to the main shaft, evidence of the dewclaws. The two-toed character of the foot is more obvious in figure 23*i*, a transverse section from about the level of the roof of the interdigital cleft.

It is only locally that sheep spoor accompany or replace those of cattle. Intense trampling by ewes with half-grown lambs (figure 22*g*) is a frequent, seasonal

event at Goldcliff (ST 340823–364823). Some sheep tracks are also recognized in the Northwick Formation at Rodley (SO 721123–745107), where their preservation is similar to that of the cattle (figure 24).

7. DISCUSSION

As Lockley (1986, 1991) and Thulborn (1990) have argued in the case of dinosaurs, the stratigraphic and areal survey of tracks in the Flandrian deposits of the inner Bristol Channel and Severn Estuary (figures 18, 23) reveals far more about the spatio-temporal distribution of the fauna of large mammals than the known skeletal remains, even allowing for the bones and teeth of hunted or managed animals concentrated by humans at the known archaeological sites. The fauna so far evident from tracks is not as diverse, however, as the assemblage indicated by known skeletal remains, which in turn is less varied than what might have been expected on general grounds (Stuart 1982). Apparently missing, aside from the two records from Magor, are the smaller of the large mammals, such as foxes, wolves and dogs. This may be more of a preservational than an ecological issue. Judging from experience in the area today, the sedimentary regime, with its emphasis on substantial but short-term erosional–depositional events, is generally speaking against the preservation of comparatively small tracks with fine anatomical detail (see below). Consequently, under normal field conditions, these tracks have much less chance of being detected than those of the larger mammals, for instance, cattle, no matter how scrupulous the search. There are other possible limitations to the record provided by tracks. For example, the skeletal remains of sheep, a domesticated introduction, are present at archaeological sites within the middle Wentlooge Formation (Allen 1997*a*), but their tracks are not known from deposits older than the lower Rumney beds (figures 18, 22). This may reflect inadequate sampling, but it also points to a small population that was either herded over large areas of salt marsh or penned in a few, small enclosures.

Humans were present on the margins of the estuary (figures 18, 22) from earlier prehistoric times, as represented by the lower Wentlooge Formation. Although the known tracks and trackways provide no definite clues, it is reasonable to suppose that the activities of these early people included hunting and wild-fowling, as well as fishing and foraging. For example, the skeletal remains recovered at the Mesolithic, estuary-margin site at Goldcliff on the Caldicot Level incorporate boar and red deer, as well as wolf/dog, fox and cat. The incidence of the larger wild mammals—notably deer—which could have been hunted for food seems to have declined steeply in the later Bronze Age and afterwards (later middle Wentlooge Formation), and this probably reflects the increasing domestication and management by humans

Figure 23. Distribution of the tracks/trackways of the larger large mammals in Flandrian (after *ca.* 1500 years BP) mudflat–salt marsh deposits of the Severn Estuary. (a) Rumney Formation (undifferentiated). (b) Awre Formation. (c) Northwick Formation.

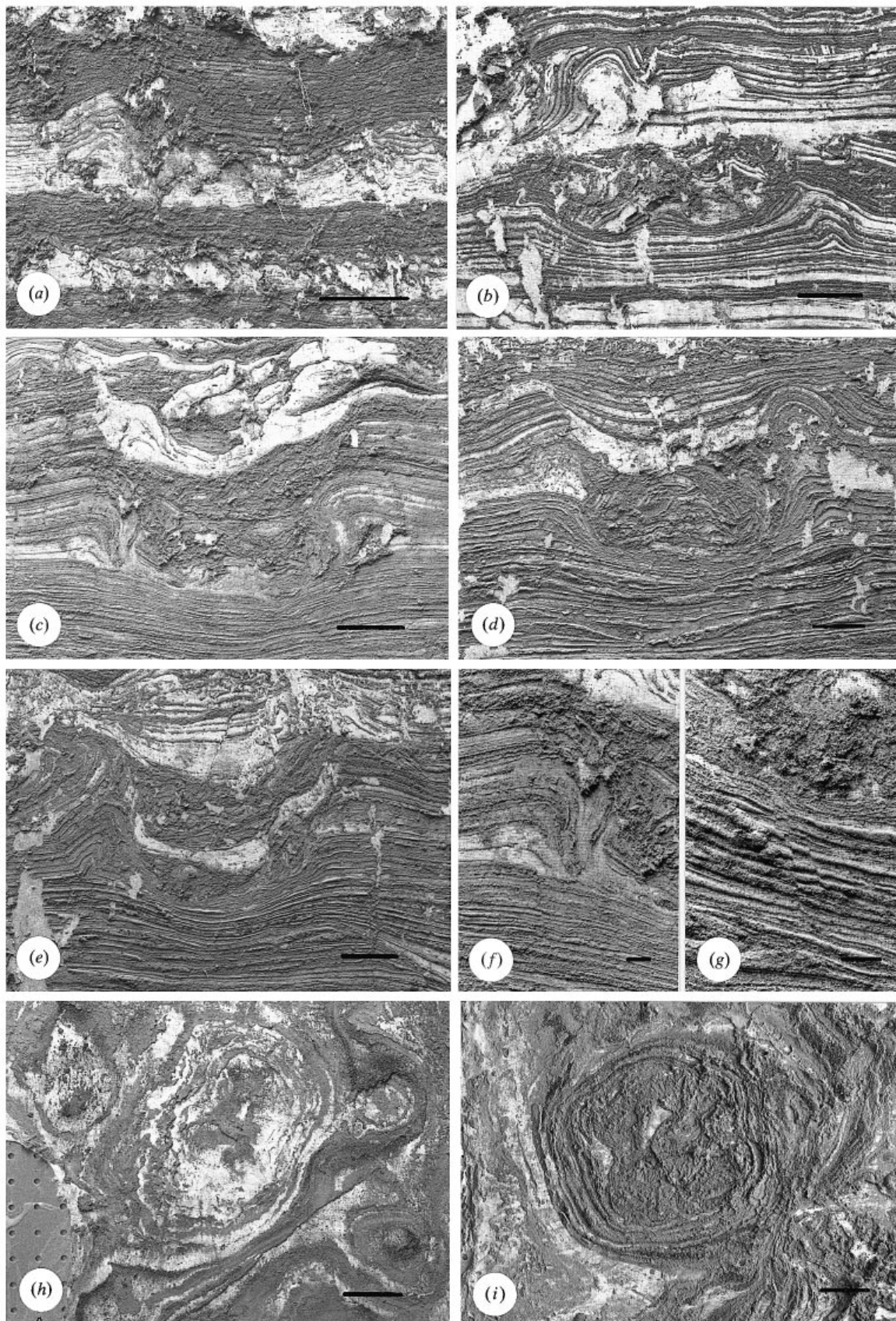

Figure 24. Cattle tracks in the Northwick Formation, Rodley (SO 721123–745107), represented by cellulose acetate peels on muslin (white in photographs). (a–e) Internal-verticle to axial sections showing effects associated with increasing relative penetration. (f) Detail of *décollement* and layer-thinning in (c). (g) Detail of microfaults beneath footprint in (e). (h, i) Transverse sections through the shaft and overprints. Note in (h) traces of external pits due to dewclaws. Scale bar equivalent to 50 mm in (a–e) and (h, i), and 10 mm in (f, g).

of animal populations on the margins of the estuary (figures 18, 23). Final Bronze Age sites on the Wentlooge Level, for instance, have yielded only cattle bones and teeth (Allen 1997*a*). At the Romano-British settlement on the Wentlooge Level (Fulford *et al.* 1994), only one fragment attributable to red deer was recorded among more than 400 bones and bone fragments assigned to horse, cattle and sheep. The situation in the twentieth century is that the Flandrian outcrop has been enclosed by sea defences practically in its entirety and exploited agriculturally in a changing variety of ways; almost without exception, the surviving salt marshes are maintained for grazing by cattle and/or sheep, and no 'wilderness' areas remain.

Human exploitation of coastal settings and resources is beginning to be attested by finds elsewhere of subfossil tracks in intertidal and other coastal sediments. Mountain (1966) described human tracks, associated with possible hyaena and bird traces, from cemented aeolian sands of probably the latest Pleistocene age on the South African littoral. Politis & Bayon (1995) found on the Argentinian coast some 420 human tracks, associated with those of sea mammals, in Flandrian tidal sediments with a radiocarbon age of some 7100 years. The shores of a coastal, saline lake in South Australia were walked over by humans of various ages and by kangaroos and emus about 5000 years ago (Belperio & Fotheringham 1990). The important site on the Sefton coast in north-west England (Gonzalez *et al.* 1996; Roberts *et al.* 1996), at which coastal silts and sands with a radiocarbon age of about 3500 years are exposed, has so far revealed 121 human trackways, chiefly of unshod children but with some of women and a few of men. At the same and nearby stratigraphic levels are tracks due to aurochs, red deer, roe deer and cranes. The purpose of the journeys made by the humans could have been foraging, given the age and gender structure of the parties.

The extent to which ecological, environmental and archaeological inferences can be drawn from tracks is partly controlled by the way tracks are made and fossilized. There are two stages in the production of an animal track that is eventually preserved in the stratigraphic record. First comes the cutting and deformation of a receptive substrate by the feet of the moving animal. Second, after the animal has moved on, comes the burial and preservation, after possible erosional modification, of the first-stage structure.

The laboratory and field observations described above demonstrate that the piercing of an ideal elastic-plastic solid by a rigid indenter or punch is a qualitatively truthful and instructive model for the first stage of track-making. In the field, as in the laboratory, tracks tend to present a constant set of features, in addition to the shaft itself. The shaft is surrounded by a deformed zone consisting of a marginal ridge and upfold, as recorded experimentally (figure 9) and from the Severn Estuary (figure 24*a–e*) and the rock record (e.g. Demathieu *et al.* 1984; Scrivner & Bottjer 1986), together with a more or less deep axial basin, as produced by the punch (figure 9) and found in the

Severn Estuary (figures 20*e*, 24*a–e*) and elsewhere (e.g. Loope 1986). In the experimental models, a regime of circumferential tension exists at least from roughly the crest outward of the marginal ridge (figure 6*e*). Some instances were found of circumferential tension beginning at the lip of the shaft (figure 7*a*). In the Severn Estuary (figure 16*b, c*), as well as in other field contexts (Scrivner & Bottjer 1986; Lockley *et al.* 1989), radial tension fractures compatible with such a pattern of forces can be seen in this position on spoor. Nadon (1993) describes fractures compatible with circumferential tension from the axial downfold in a dinosaur track.

The inferences by Scrivner & Bottjer (1986) about the role of sediment moisture content in determining the character and faithfulness to anatomical detail of tracks, supplemented by the direct observations of Cohen *et al.* (1991) from the shores of Lake Manyara (Tanzania), are in general supported by the field experiments carried out in the Severn Estuary (figure 16). Anatomical features are best preserved where animals travelled over stiff to firm mud. However, the range of theoretical models (figures 3, 4), together with certain field observations (figure 24*a–e*), suggest that a significant role is also played by 'rheological stratigraphy', namely, the extent to which the sediment is vertically uniform in the properties of grain size, mineralogy and moisture content that confer strength. The rule in the estuary seems to be either a gradual or an abrupt and stepwise downward increase in strength. Thus the upper part of a track may present the features to be expected from a sediment of high moisture content (e.g. slumping of the sides), while the lower part has the quality of a structure formed in a more consolidated and less moist substrate (e.g. preservation of fine anatomical detail, a short vertical sequence of undertraces). One restriction on the theoretical and laboratory models employed so far is that they are limited to uniform materials, any supporting substrate being supposed to be perfectly rigid. Future experiments should be quantitative and tackle vertically non-uniform as well as uniform plastic materials.

The second stage in the formation of a track is the burial of the structure. This stage is complex, at least in the inner Bristol Channel and Severn Estuary, judging from general experience of the sedimentary regime and of the wide variety of ways in which tracks are exposed to view in the field (figures 19, 20, 22, 24). The many time-scales on which accretion–erosion occurs mean that a shaft may on several occasions be partly filled, partly or wholly emptied, and its upper part erosively modified before final burial is achieved. Partial desiccation of the sediment, even to the point of fracturing, is not uncommon. Locally, a high proportion of tracks become modified through trampling by later track-makers (e.g. figures 16*g, h*; 22*e, g*). The frequency, duration and severity of these modifying events all influence what Cohen *et al.* (1991), in their specifically taphonomic study, have described as the 'survivorship' and 'deterioration' of tracks. What ultimately survives in the Severn Estuary expresses in part a trade-off between shallow shafts with finely

detailed footprints, of low survivability in a very dynamic regime of many erosional events, and deep shafts that contain only crude footprints, with a higher survivability under such a regime. Controlled taphonomic experiments over time in the Severn Estuary would repay, but the conditions for them would be somewhat artificial, given the paucity of wild mammals.

The subfossil tracks preserved in the Severn Estuary are presented at outcrop to the observer in many different modes (figures 19, 20, 21, 22, 24), as undertraces of varying degrees of detail, as overtraces from a range of levels in the shafts, as emptied shafts, and as footprints. No attempt has been made to quantify the relative abundance of these different modes, but it is clear qualitatively that footprints, by a significant degree, are the least common. Since footprints vary from the crudest (soft mud) to the finely detailed (firm mud), only a very small proportion of the tracks in the area would seem capable of yielding unchallengeable taxonomic information about the animals that made them. Taxonomic, ecological and environmental inferences about extinct species are particularly difficult, but the process would be aided by paying greater attention than has been paid in the past to the preservational aspects of tracks.

8. CONCLUSIONS

(1) The track made by an animal as it moves over a receptive deposit consists of a volume of sediment that displays a constant deformation geometry, including a shaft with footprint at the base, around the shaft a marginal surface ridge above an upfold, and beneath the shaft an axial downfold accompanied by a vertical sequence of undertraces. Depending on preservational conditions, laminae with overtraces may partly or wholly fill the shaft.

(2) Laboratory experiments using Plasticine configured to provide a variety of strain markers, together with observations from the mudflats and salt marshes and their deposits of the inner Bristol Channel and Severn Estuary, confirm that the piercing of an ideal elastic–plastic solid by a rigid indenter is a valid model for the response of a receptive sediment to the limbs of an animal travelling over it. The depth and detailed character of a track is a function of the strength of the sediment, as controlled particularly by moisture content and its vertical variation. Generally speaking, the shallowest tracks, which best preserve anatomical detail, occur in the least moist deposits. Sediment moisture content is changeable, and a function of climate and position in the tidal frame.

(3) Once an animal has withdrawn its limb and moved away, the shaft and its surrounding deformed zone are subject to modifying events (accretion, erosion, desiccation, trampling by other animals) before final preservation is achieved. It is at this stage that overtraces, recording either anatomical details on the foot, or merely its outline, can form within the shaft.

(4) Sparsely distributed skeletal remains from the Flandrian deposits of the inner Bristol Channel and

Severn Estuary reveal the presence of a varied fauna of larger mammals on the marginal salt marshes and high mudflats. Tracks recorded from the sediments show the presence of a fauna of larger mammals from the earlier Flandrian onward, and demonstrate that the animals ranged far and wide in these environments. Humans were included, together with cattle (wild and domestic), deer and sheep/goat. Issues of preservation and sampling may explain the lack of records in the form of tracks of the smaller of the large mammals. The stratigraphic sequence of track assemblages reveals the gradual displacement of wild species, such as deer, by domesticated animals, as the degree of human intervention in the area grew.

It is a pleasure to record my gratitude to Denys Hutchings, who helped me construct the apparatus for the laboratory experiments, and Annie Grant (University of Leicester), for advice on animal anatomy and general discussion. I am especially grateful to Derek Upton of Caldicot, who gave me photographs of tracks he found and allowed me to reproduce a human trackway.

REFERENCES

- Aldhouse-Green, S. H. R., Whittle, A. W. R., Allen, J. R. L. *et al.* 1992 Prehistoric human footprints from the Severn Estuary at Uskmouth and Magor Pill, Gwent, Wales. *Archaeologia Cambrensis* **149**, 14–55.
- Allen, J. R. L. 1982 *Sedimentary structures: their character and physical basis*. Amsterdam: Elsevier.
- Allen, J. R. L. 1984 Truncated fossil thermal contraction polygons (?Devensian) in the Mercia Mudstone Formation (Trias), Oldbury upon Severn, Gloucestershire. *Proc. Geol. Ass.* **95**, 263–273.
- Allen, J. R. L. 1986 A short history of salt-marsh reclamation at Slimbridge Warth and neighbouring areas, Gloucestershire. *Trans. Bristol Gloucestershire Archaeol. Soc.* **104**, 139–155.
- Allen, J. R. L. 1987*a* Desiccation of mud in the temperate intertidal zone: studies from the Severn Estuary and Eastern England. *Phil. Trans. R. Soc. Lond. B* **315**, 127–156.
- Allen, J. R. L. 1987*b* Reworking of muddy intertidal sediments in the Severn Estuary, southwestern, UK: a preliminary survey. *Sediment. Geol.* **50**, 1–23.
- Allen, J. R. L. 1987*c* Towards a quantitative chemostratigraphic model for sediments of late Flandrian age in the Severn Estuary, UK. *Sediment. Geol.* **53**, 73–100.
- Allen, J. R. L. 1987*d* Late Flandrian shoreline oscillations in the Severn Estuary: the Rumney Formation at its type site (Cardiff area). *Phil. Trans. R. Soc. Lond. B* **315**, 157–184.
- Allen, J. R. L. 1987*e* Dimlington Stadial (late Devensian) ice-wedge casts and involutions in the Severn Estuary, southwest Britain. *Geol. J.* **22**, 109–118.
- Allen, J. R. L. 1988 Modern-period muddy sediments in the Severn Estuary (southwestern UK): a pollutant-based model for dating and correlation. *Sediment. Geol.* **58**, 1–21.
- Allen, J. R. L. 1989 Fossil vertebrate tracks and indenter mechanics. *J. Geol. Soc. Lond.* **146**, 600–602.
- Allen, J. R. L. 1990*a* The Severn Estuary in southwest Britain: its retreat under marine transgression, and fine-sediment regime. *Sediment. Geol.* **66**, 13–28.
- Allen, J. R. L. 1990*b* Salt-marsh growth and stratification: a numerical model with special reference to the Severn Estuary, southwest Britain. *Marine Geol.* **95**, 77–96.

- Allen, J. R. L. 1991 Fine sediment and its sources, Severn Estuary and inner Bristol Channel, southwest Britain. *Sediment. Geol.* **75**, 57–65.
- Allen, J. R. L. 1997a Three final Bronze Age occupations at Rumney Great Wharf on the Wentlooge Level, Gwent. *Studia Celtica*.
- Allen, J. R. L. 1997b A medieval timber setting and sub-rectangular diggings in late Flandrian estuarine sediments, Rumney Great Wharf, Gwent. *Archaeologia Cambrensis*.
- Allen, J. R. L. & Fulford, M. G. 1987 Romano-British settlement and industry on the wetlands of the Severn Estuary. *Antiq. J.* **67**, 237–289.
- Allen, J. R. L. & Fulford, M. G. 1992 Romano-British and later geoaerchaeology at Oldbury Flats: reclamation and settlement on the changeable coast of the Severn Estuary, south west Britain. *Archaeol. J.* **149**, 82–123.
- Allen, J. R. L. & Fulford, M. G. 1996 Late Flandrian coastal change and tidal palaeochannel development at Hills Flats, Severn Estuary (S.W. Britain). *J. geol. Soc. Lond.* **153**, 151–162.
- Allen, J. R. L. & Rae, J. E. 1987 Late Flandrian shoreline oscillations in the Severn Estuary: a geomorphological and stratigraphical reconnaissance. *Phil. Trans. R. Soc. Lond. B* **315**, 185–230.
- Allen, J. R. L. & Rippon, S. J. 1997 Iron Age to early modern activity at Magor Pill and palaeochannels, Gwent: an exercise in lowland coastal-zone geoaerchaeology. *Antiq. J.*
- Anderson, J. G. C. 1968 The concealed rock surface and overlying deposits of the Severn Valley from Upton to Neath. *Proc. South Wales Inst. Engrs* **83**, 27–47.
- Anderson, J. G. C. 1974 The buried channels, rock floors and rock basins, and overlying deposits, of the South Wales valleys from Wye to Neath. *Proc. South Wales Inst. Engrs* **88**, 11–25.
- Anderson, J. G. C. & Blundell, C. R. K. 1965 The sub-drift rock-surface and buried valleys of the Cardiff district. *Proc. Geol. Ass.* **76**, 367–378.
- Andrews, J. T., Gilbertson, D. D. & Hawkins, A. B. 1984 The Pleistocene succession of the Severn Estuary: a revised model based upon amino acid racemization studies. *J. geol. Soc. Lond.* **141**, 967–974.
- Ashdown, R. R. & Done, S. 1984 *Colour atlas of veterinary anatomy. Vol. 1. The Ruminants*. London: Baillière Tindall.
- Bahn, P. G. & Vertut, J. 1988 *Images of the Ice Age*. Leicester: Windward.
- Bang, P. & Dahlstrom, P. 1974 *Animal tracks and signs*. London: Collins.
- Barnes, I. 1993 Second Severn Crossing: English approaches, an interim statement on the 1992/93 fieldwork. In *Annual Report of the Severn Estuary Levels Research Committee for 1993* (ed. M. Bell), pp. 5–29, 119–125. Lampeter.
- Barone, R. 1976 *Anatomie comparée des mammifères domestiques. Tome premier, Osteologie, Fascicule 1 (texte), Fascicule 2 (atlas)*. Paris: Vigot Frères.
- Beckinsale, R. P. & Richardson, L. 1964 Recent findings on physical development of the Lower Severn Valley. *Geogr. J.* **130**, 87–105.
- Béguen, R. & Clottes, J. 1984 Grotte du Tuc d'Audonbert. In *l'Art des cavernes*, pp. 410–415. Paris: Ministère de la Culture.
- Behrensmeyer, A. K. & Laporte, L. F. 1981 Footprints of a Pleistocene hominid in northern Kenya. *Nature, Lond.* **289**, 167–169.
- Bell, M. 1993 Field survey and excavation at Goldcliff, Gwent 1993. In *Annual Report of the Severn Estuary Levels Research Committee for 1993* (ed. M. Bell), pp. 81–101, 119–125. Lampeter.
- Bell, M. 1995 Field survey and excavation at Goldcliff, Gwent 1994. In *Annual Report of the Severn Estuary Levels Research Committee for 1994* (ed. M. Bell), pp. 115–144, 157–165. Lampeter.
- Belperio, A. P. & Fotheringham, D. G. 1990 Geological setting of two Quaternary footprint sites, western South Australia. *Aust. J. Earth Sci.* **37**, 37–42.
- Bishop, R. F., Hill, R. & Mott, N. F. 1945 The theory of indentation and hardness tests. *Proc. Phys. Soc.* **57**, 147–159.
- Bjork, P. R. 1976 Mammalian tracks from the Brule Formation of South Dakota. *Proc. South Dakota Acad. Sci.* **55**, 154–158.
- Bouchner, M. 1982 *A field guide in colour to animal tracks and traces*. London: Octopus Books.
- Bouma, A. H. 1969 *Methods for the study of sedimentary structures*. New York: Wiley-Interscience.
- Bower, A. F., Fleck, N. A., Needleman, A. & Ogbonna, N. 1993 The indentation of a power law creeping solid. *Proc. R. Soc. Lond. A* **441**, 97–124.
- Brand, L. 1979 Field and laboratory studies on the Coconino Sandstone (Permian) vertebrate footprints and their paleo-ecological implications. *Palaeogeogr. Palaeoclimatol. Palaeoecol.* **28**, 25–38.
- Brown, A. P. 1911 The formation of ripple-marks, tracks, and trails. *Proc. Acad. Nat. Sci. Philadelphia* **63**, 536–547.
- Brown, R. W. 1947 Fossil plants and human footprints in Nicaragua. *J. Paleont.* **21**, 38–40.
- Burd, F. 1989 *The saltmarsh survey of Great Britain*. Peterborough: Nature Conservancy Council.
- Burton, R. G. O. & Hodgson, J. M. 1987. *Lowland peat in England and Wales*. Harpenden: Soil Survey of England and Wales.
- Calladine, C. R. 1969 *Engineering plasticity*. Oxford: Pergamon Press.
- Cave, R. 1977 Geology of the Malmesbury district. *Mem. Geol. Surv. UK*
- Chandler, T. J. & Gregory, S. 1976 *The climate of the British Isles*. London: Longman.
- Chaffee, R. G. 1943 Mammal footprints from the White River Oligocene. *Notulae naturae* **116**, 1–13.
- Clottes, J. & Simonnet, R. 1972 Le réseau René Clastres de la Caverne de Niaux. *Bull. Soc. Préhist. Fr.* **69**, 293–323.
- Clottes, J. & Simonnet, R. 1984 Le réseau René Clastres. In *l'Art des Cavernes*, pp. 424–427. Paris: Ministère de la Culture.
- Codrington, T. 1898 On some submerged rock-valleys in South Wales, Devon and Cornwall. *Q. J. Geol. Soc. Lond.* **54**, 251–276.
- Cohen, A. S., Halfpenny, J., Lockley, M. & Michel, E. 1993 Modern vertebrate tracks from Lake Manyara, Tanzania, and their palaeobiological implications. *Palaeobiology* **19**, 433–458.
- Cohen, A. S., Lockley, M., Halfpenny, J. & Michel, A. E. 1991 Modern vertebrate track taphonomy at Lake Manyara, Tanzania. *Palaios* **6**, 371–389.
- Collins, M. B. 1987 Sediment transport in the Bristol Channel: a review. *Proc. Geol. Ass.* **98**, 367–383.
- Cram, L. & Fulford, M. G. 1979 Silchester tile making—the faunal environment. In *Roman brick and tile* (ed. A. McWhirr), pp. 201–209. Oxford: BAR International Series No. 68.
- Currie, P. J., Nadon, G. C. & Lockley, M. G. 1991 Dinosaur footprints with skin impressions from the Cretaceous of Alberta and Colorado. *Can. J. Earth Sci.* **28**, 102–115.
- Day, M. H. & Wickens, E. H. 1980 Laetoli Pliocene hominid footprints and bipedalism. *Nature, Lond.* **286**, 385–387.
- Delair, J. B. & Sarjeant, W. A. S. 1985 History and

- bibliography of the study of fossil vertebrate footprints in the British Isles: supplement 1973–83. *Palaeogeogr. Palaeoclimatol. Palaeoecol.* **49**, 123–160.
- Demathieu, G., Ginsburg, L. & Truc, G. 1984 Etude paléontologique, ichnologique et paléocéologiques du gisement Oligocène de Saignan (Bassin d'Apt, Vaucluse). *Bull. Mus. Hist. Nat., Paris* (4)6(C), 153–183.
- Edmonds, E. A. & Williams, B. J. 1985 Geology of the country around Taunton and the Quantock Hills. *Mem. geol. Surv. UK*.
- Ennion, E. A. R. & Tinbergen, N. 1967 *Tracks*. Oxford: Clarendon Press.
- Falkus, H. 1978 *Nature detective*. London: Gollancz.
- Faton, A. & Richet, C. 1985 Traces et messages de la Préhistoire. *Histoire et Archéologie* **90**, 8–98.
- Fichter, J. 1982 Aktuopaläontologische Untersuchungen an der Fährten einheimischer Urodelen und Lacertilien. I. Die Morphologie der Fährten in Abhängigkeit von der Sedimentbeschaffenheit. *Mainzer Naturw. Arch.* **20**, 90–129.
- Fichter, J. 1983 Aktuopaläontologische Untersuchungen an der Fährten einheimischer Urodelen und Lacertilien. II. Aktuopaläontologische-Quantitative Fährtenanalyse. *Mainzer Naturw. Arch.* **21**, 25–66.
- Fowler, P. J., Bennett, J. & Hill, V. S. 1976 Archaeology and the M5 Motorway. *Trans. Bristol Gloucestershire Archaeol. Soc.* **94**, 47–91.
- French, P. W. 1993 Areal distribution of selected pollutants in contemporary tidal sediments of the Severn Estuary and Bristol Channel. *Marine Pollut. Bull.* **26**, 692–697.
- Frey, R. W. & Pemberton, S. G. 1986 Vertebrate Lebenspuren in intertidal and supratidal environments, Holocene barrier islands, Georgia. *Senckenbergiana maritima* **18**, 45–95.
- Frey, R. W. & Pemberton, S. G. 1987 The *Pselionichnus* ichnocoenose, and its relationship to adjacent marine and nonmarine ichnocoenoses along the Georgia coast. *Bull. Can. Soc. Petrol. Geol.* **35**, 333–357.
- Frostick, L. E. & Reid, I. 1986 Evolution and sedimentary character of lake deltas fed by ephemeral rivers in the Turkana basin, northern Kenya. In *Sedimentation in the African Rifts* (ed. L. E. Frostick). *Geol. Soc. Lond. Spec. Publ.* **25**, 113–125.
- Fryberger, S. G., Al-Sari, A. M. & Clisham, T. J. 1983 Eolian dune, interdune, sand sheet, and siliciclastic sabkha sediments of an offshore prograding sand sea, Dhahran area, Saudi Arabia. *Bull. Am. Ass. Petrol. Geol.* **67**, 280–312.
- Fulford, M. G., Allen, J. R. L. & Rippon, S. J. 1994 The settlement and drainage of the Wentlooge Level, Gwent: excavation and survey at Rumney Great Wharf 1992. *Britannia* **25**, 175–211.
- Gilbertson, D. D. & Hawkins, A. B. 1978 The Pleistocene succession at Kenn, Somerset. *Bull. Geol. Surv. Gr. Br.* **66**, 1–41.
- Gilbertson, D. D. & Hawkins, A. B. 1983 Periglacial slope deposits and frost structures along the southern margin of the Severn estuary. *Proc. Univ. Bristol Spelaol. Soc.* **16**, 175–184.
- Gilbertson, D. D., Hawkins, A. B., Mills, C. M., Harkness, D. D. & Hunt, C. O. 1990 The late Devensian and Holocene of industrial Severnside and the Vale of Gordan: stratigraphy, radiocarbon dating and palaeoecology. *Proc. Ussher Soc.* **7**, 279–284.
- Gillette, D. D. 1986 *First International Symposium on Dinosaur tracks and traces. Abstracts with Program*. Albuquerque: New Mexico Museum of Natural History.
- Gillette, D. D. & Lockley, M. G. 1989 *Dinosaur tracks and traces*. Cambridge University Press.
- Ginsburg, L., de Lapparent, A. F., Loiret, B. & Taquet, P. 1966 Empreintes de pas vertébrés tétrapodes dans la séries continentales de l'ouest d'Agades (République du Niger). *C.r. Acad. Sci., Paris D* **263**, 28–31.
- Godwin, H. 1948 Studies of the postglacial history of British vegetation. X. Correlation between climate, forest composition, prehistoric agriculture and peat stratigraphy in the Sub-boreal and Sub-Atlantic peats of the Somerset Levels. *Phil. Trans. R. Soc. Lond. B* **233**, 275–286.
- Godwin, H. & Willis, E. H. 1964 Cambridge University natural radiocarbon measurements III. *Radiocarbon* **6**, 116–137.
- Godwin-Austen, R. A. C. 1865 On the submerged forest-beds of Porlock Bay. *Q. J. Geol. Soc. Lond.* **22**, 1–9.
- Goldring, R. & Seilacher, A. 1971 Limulid undertracks and their sedimentological implications. *Neues Jb. Geol. Paläont. Abh.* **37**, 422–442.
- Gonzalez, S., Huddart, D. & Roberts, G. 1996 Holocene development of the Sefton coast: a multidisciplinary approach to understanding the archaeology. In *Archaeological Science 1995*, vol. 2 (ed. A. Sinclair, E. Slater & J. Gowlett), pp. 271–281. Oxford: Oxbow Books.
- Green, A. P. 1951. The use of Plasticine models to simulate the plastic flow of metals. *Phil. Mag.* (7) **42**, 365–373.
- Green, G. W. & Welch, F. B. A. 1965 Geology of the country around Wells and Cheddar. *Mem. Geol. Surv. UK*.
- Green, H. S. 1989 Some recent archaeological and faunal discoveries from the Severn Estuary Levels. *Bull. Board Celtic Stud.* **36**, 187–199.
- Haberland, W. & Grebe, W.-H. 1955 Prehistoric footprints from El Salvador. *Amer. Antiq.* **22**, 282–285.
- Hawkins, A. B. 1962 The buried channel of the Bristol Avon. *Geol. Mag.* **99**, 369–374.
- Hawkins, A. B. 1968 The geology of the Portbury area. *Proc. Bristol Nat. Soc.* **31**, 421–428.
- Hawkins, A. B. 1971 Sea-level changes around south-west England. In *Marine archaeology* (ed. D. J. Blackman), pp. 67–87. London: Butterworths.
- Hay, R. L. & Leakey, M. D. 1982 The fossil footprints of Laetoli. *Sci. Amer.* **246**, 38–45.
- Hewlett, R. & Birnie, J. 1996 Holocene environmental change in the inner Severn Estuary, UK: an example of the response of estuarine sedimentation to relative sea-level change. *The Holocene* **6**, 49–61.
- Hey, R. W. 1991 Pleistocene gravels in the lower Wye Valley. *Geol. J.* **26**, 123–136.
- Heyler, D. & Lessertisseur, J. 1963 Pistes de tétrapodes Permians dans la région de Lodève (Hérault). *Mém. Mus. Nat. Hist. Nat., Paris* **C11**, 125–221.
- Heyworth, A. & Kidson, C. 1982 Sea-level changes in southwest England and Wales. *Proc. Geol. Ass.* **93**, 91–111.
- Hill, R. 1971 *The mathematical theory of plasticity*. Oxford: Clarendon Press.
- Hill, R. 1992 Similarity analysis of creep indenter tests. *Proc. R. Soc. Lond. A* **436**, 617–630.
- Hill, R., Storakers, B. & Zdunek, A. B. 1989 A theoretical study of the Brinell hardness test. *Proc. R. Soc. Lond. A* **423**, 301–330.
- Hitchcock, E. 1858 *A report on the sandstone of the Connecticut valley and its fossil footmarks*. Boston: White.
- Hyde, H. A. 1936 On a peat bed at East Moors, Cardiff. *Trans. Cardiff Nat. Soc.* **69**, 39–48.
- Hydraulics Research Station 1981 *The Severn Estuary: silt monitoring, April 1980–March 1981*. Wallingford: Hydraulics Research Station.
- Jaeger, E. 1948 *Tracks and trailcraft*. New York: Macmillan.
- Jefferies, R. L., Willis, A. J. & Yemm, E. W. 1968 The late- and post-glacial history of the Gordan Valley, north Somerset. *New Phytol.* **67**, 335–348.
- Johnson, A. M. 1970 *Physical processes in geology*. San Francisco: Freeman, Coope.

- Johnson, A. M. 1977 *Styles of folding. Mechanics and mechanisms of folding of natural elastic materials*. Amsterdam: Elsevier.
- Johnson, A. M. & Fletcher, R. C. 1994 *Folding of viscous layers: mechanical analysis and interpretation of structures in deformed rocks*. New York: Columbia University Press.
- Johnson, W., Sowerby, R. & Haddow, J. B. 1970 *Plane-strain slip-line fields*. London: Arnold.
- Johnson, W., Sowerby, R. & Venter, R. D. 1982 *Plane-strain slip-line fields for metal-deformation processes*. Oxford: Pergamon Press.
- Kellaway, G. A. & Welch, F. B. A. 1993 Geology of the Bristol district. *Mem. Geol. Surv. UK*.
- Kidan, T. W. & Cosgrove, J. W. 1996 The deformation of multilayers by layer-normal compression; an experimental investigation. *J. Struct. Geol.* **18**, 461–474.
- Kidson, C. & Heyworth, A. 1976 The Quaternary deposits of the Somerset Levels. *Q. J. Engng Geol.* **9**, 217–235.
- Kirby, R. 1986 *Suspended fine cohesive sediment in the Severn Estuary and inner Bristol Channel, UK*. London: Rep. No. ETSU-STP-4042, Energy Technology Support Unit, Department of Energy.
- Lambe, T. W. & Whitman, R. V. 1969 *Soil mechanics*. New York: Wiley.
- Laury, R. L. 1980 Paleoenvironment of late Quaternary mammoth-bearing sinkhole deposit, Hot Springs, South Dakota. *Bull. Geol. Soc. Am.* **91**, 465–475.
- Lawrence, M. J. & Brown, R. W. 1973 *Mammals of Britain, their tracks, trails and signs*, 2nd edn. London: Blandford.
- Lea, P. D. 1996 Vertebrate tracks in Pleistocene eolian sand-sheet deposits of Alaska. *Quat. Res.* **45**, 226–240.
- Leakey, M. D. 1987 Animals prints and trails. In *Laetoli: a Pliocene site in northern Tanzania* (ed. M. D. Leakey & J. M. Harris), pp. 451–489. Oxford: Clarendon Press.
- Leakey, M. D. & Hay, R. L. 1979 Pliocene footprints in the Laetoli Beds at Laetoli, northern Tanzania. *Nature, Lond.* **278**, 317–323.
- Leakey, M. D., Robbins, L. M. & Tuttle, R. H. 1987 The hominid footprints. In *Laetoli: a Pliocene site in northern Tanzania* (ed. M. D. Leakey & J. M. Harris), pp. 490–523. Oxford: Clarendon Press.
- Leese, C. E. & Vernon, W. F. 1960 Basal gravel in the alluvium near Severn Beach. *Proc. Bristol Nat. Soc.* **30**, 139–142.
- Leonardi, G. 1987 *Glossary and manual of tetrapod footprint palaeoichnology*. Brasilia: Ministério das Minas e Energia.
- Leonardi, G. & Sarjeant, W. A. S. 1986 Footprints representing a new Mesozoic vertebrate fauna from Brazil. *Modern Geology* **10**, 73–84.
- Leutscher, A. 1960 *Tracks and signs of British animals*. London: Cleaver-Hume.
- Levin, E. 1955 Indentation pressure of a smooth circular punch. *Q. Appl. Math.* **13**, 133–137.
- Lewis, D. W. & Titheridge, D. G. 1978 Small scale sedimentary structures resulting from foot impressions in dune sands. *J. Sedim. Petrol.* **48**, 835–838.
- Locke, S. 1970–71 The postglacial deposits of the Caldicot Level and some associated archaeological discoveries. *Monmouthsh. Antiq.* **3**(1), 1–16.
- Lockley, M. G. 1986 The palaeobiological and palaeo-environmental importance of dinosaur footprints. *Palaios* **1**, 37–47.
- Lockley, M. G. 1991a *Tracking dinosaurs. A new look at an ancient world*. Cambridge University Press.
- Lockley, M. G. 1991b The dinosaur footprint renaissance. *Modern Geology* **16**, 139–160.
- Lockley, M. G. & Hunt, A. P. 1995 *Dinosaur tracks and other fossil footprints of the western United States*. New York: Columbia University Press.
- Lockley, M. G., Houck, K. & Prince, N. K. 1986 North America's largest dinosaur trackway site: implications for Morrison Formation paleoecology. *Bull. Geol. Soc. Am.* **97**, 1163–1176.
- Lockley, M. G., Matsukawa, M. & Obata, I. 1989 Dinosaur tracks and radial cracks: unusual footprint features. *Bull. Natn. Sci. Mus., Tokyo* **C15**, 151–160.
- Lockley, M. G., Dos Santos, V. F., Meyer, C. A. & Hunt, A. 1994 Aspects of sauropod paleobiology. *Gaia* **10**, 1–279.
- Loope, D. B. 1986 Recognizing and utilizing vertebrate tracks in cross-section: Cenozoic hoofprints from Nebraska. *Palaios* **1**, 141–152.
- Loope, D. L. & Simpson, E. L. 1992 Significance of thin sets of eolian cross-strata. *J. Sedim. Petrol.* **62**, 849–859.
- Lucy, W. C. 1877 The submerged forest, Holly Hazle, Sharpness. *Proc. Cotteswold Nat. Fld Club* **6**, 105–125.
- Maddy, D. Green, C. P., Lewis, S. G. & Bowen, D. Q. 1995 Pleistocene geology of the lower Severn Valley, UK. *Quat. Sci. Rev.* **14**, 209–222.
- Maltman, A. J. 1988 The importance of shear zones in naturally deformed wet sediments. *Tectonophysics* **145**, 163–175.
- Marti, J., Ablay, G. J., Redshaw, L. T. & Sparks, R. S. J. 1994 Experimental studies of collapse calderas. *J. Geol. Soc. Lond.* **151**, 919–929.
- McClay, K. 1976 The rheology of Plasticine. *Tectonophysics*, **33**, T7–T15.
- McKee, E. D. 1947 Experiments on the development of tracks in fine cross-bedded sand. *J. Sedim. Petrol.* **17**, 23–28.
- McKeever, P. 1991 Trackway preservation in eolian sandstones from the Permian of Scotland. *Geology* **19**, 726–729.
- McKeever, P. J. 1994 The behavioral and biostratigraphical significance and origin of vertebrate trackways from the Permian of Scotland. *Palaios* **9**, 477–487.
- McLaren, P., Collins, M. B., Gao, S. & Powys, R. I. L. 1993 Sediment dynamics of the Severn Estuary and inner Bristol Channel. *J. Geol. Soc. Lond.* **150**, 589–603.
- Michel, F. 1968 Tierspuren auf römischen Ziegeln. *Jber. Hist. Mus. Schloss Thun 1968*, 3–31.
- Mountain, E. D. 1966 Footprints in calcareous sandstone at Nahoon Point. *S. Afr. J. Sci.* **62**, 103–111.
- Murie, O. J. 1954 *A field guide to animal tracks*. Boston: Houghton Mifflin.
- Murray, J. W. & Hawkins, A. B. 1976 Sediment transport in the Severn Estuary during the past 8000 to 9000 years. *J. Geol. Soc. Lond.* **132**, 385–398.
- Nadon, G. C. 1993 The association of anastomosed fluvial deposits and dinosaur tracks, eggs and nests: implications for the interpretation of floodplain environments and a possible survival strategy for ornithopods. *Palaios* **8**, 31–44.
- Nayling, N. 1992 Caldicot Castle lake, In *Annual Report of the Severn Estuary Levels Research Committee for 1992* (ed. M. Bell), pp. 11–14, 75–76. Lampeter.
- Padian, K. & Olsen, P. E. 1984 Footprints of the Komodo monitor and the trackways of fossil reptiles. *Copeia* **3**, 662–671.
- Parkhouse, J. 1991 Goldcliff. In *Annual Report of the Severn Estuary Levels Research Committee for 1990* (ed. M. Bell), pp. 11–14, 20–21. Lampeter.
- Parrey, R. H. G. 1972 *Stress-strain behaviour of soils*. Henley-on-Thames: Foulis.
- Peabody, F. E. 1959 Trackways of living and fossil salamanders. *Publs. Zool. Univ. California* **63**, 1–72.
- Politis, G. G. & Bayon, C. 1995 Early Holocene human footprints and sea mammals in the tidal zone of the Argentinian foreshore. *Past* **20**, 5–6.
- Prandtl, L. 1920 Über die Härte plastischer Körper. *Göttinger Nachr. Math. Phys. Kl.* **1920**, 74–85.

- Prevost, E. W., Reader, T. M., Kennard, A. S. & Woodward, B. B. 1901 The peat and forest bed at Westbury-on-Severn. *Proc. Cotteswold Nat. Fld Club* **9**, 17–46.
- Price, N., 1995 Houses and horses in the Swedish Bronze Age. *Past* **20**, 10–12.
- Ramberg, H. 1981 *Gravity, deformation and the Earth's crust*, 2nd edn. London: Academic Press.
- Reineck, H.-E. & Howard, J. R. 1978 Alligatorfahrten. *Natur Mus., Frankf.* **108**, 10–15.
- Reiner, M. 1969 *Deformation, strain and flow*, 3rd edn. London: Lewis.
- Robbins, L. M. 1985 *Footprints. Collection, analysis and interpretation*. Springfield: Thomas.
- Roberts, G., Gonzalez, S. & Huddart, D. 1996 Intertidal Holocene footprints and their archaeological significance. *Antiquity* **70**, 647–651.
- Robertson, G. M. & Sternberg, G. F. 1942 Fossil mammal tracks in Graham County, Kansas. *Trans. Kansas Acad. Sci.* **45**, 258–260.
- Rollason, E. C. 1973 *Metallurgy for engineers*, 4th edn. London: Arnold.
- Sarjeant, W. A. S. 1974 A history and bibliography of the study of fossil footprints in the British Isles. *Palaeogeogr. Palaeoclimatol. Palaeoecol.* **16**, 165–378.
- Sarjeant, W. A. S. 1975 Fossil tracks and impressions of vertebrates. In *The study of trace fossils* (ed. R. W. Frey), pp. 283–324. New York: Springer-Verlag.
- Sarjeant, W. A. S. 1987 The study of fossil vertebrate footprints—a short history and selective bibliography. In *Glossary and manual of tetrapod footprint palaeoichnology* (ed. G. Leonardi), pp. 1–19. Brasilia: Ministério das Minas e Energia.
- Scaife, R. & Long, A. 1995 Evidence for Holocene sea-level changes at Caldicot Pill. In *Annual Report of the Severn Estuary Levels Research Committee for 1994* (ed. M. Bell), pp. 81–85, 157–165. Lampeter.
- Scarboro, D. D. & Tucker, M. E. 1995 Amphibian footprints from the mid-Carboniferous of Northumberland, England: sedimentological context, preservation and significance. *Palaeogeogr. Palaeoclimatol. Palaeoecol.* **113**, 335–349.
- Scrivner, P. J. & Bottjer, D. J. 1986 Neogene avian and mammalian tracks from Death Valley National Monument, California: their context, classification and preservation. *Palaeogeogr. Palaeoclimatol. Palaeoecol.* **57**, 285–331.
- Seddon, B. 1964 Submerged peat layers in the Severn channel near Avonmouth. *Proc. Bristol Nat. Soc.* **31**, 101–106.
- Seilacher, A. 1953 Studien zur Palichnologie. I. Über die Methoden der Palichnologie. *Neues. Jb. Geol. Paläontol., Abh.* **96**, 421–452.
- Shennan, I. 1989 Holocene crustal movements and sea-level change in Great Britain. *J. Quat. Sci.* **4**, 77–89.
- Shield, R. T. 1955 The plastic indentation of a layer by a flat punch. *Q. Appl. Math.* **13**, 27–46.
- Shield, R. T. & Drucker, D. C. 1953 The application of limit analysis to punch-indentation problems. *J. Appl. Math.* **20**, 453–460.
- Smith, A. G. & Miorgan, L. A. 1989 A succession to ombrotrophic bog in the Gwent Levels, and its demise: a Welsh parallel to the peats of the Somerses Levels. *New Phytol.* **112**, 145–167.
- Smith, K., Coppen, J., Wainwright, G. J. & Becket, S. 1981 The Shaugh Moor project; third report—settlement and environmental investigation. *Proc. Prehist. Soc.* **47**, 205–273.
- Smith, R. M. H. 1993 Sedimentology and ichnology of floodplain paleosurfaces in the Beafort Group (late Permian), Karoo sequence, South Africa. *Palaios* **8**, 339–357.
- Smith, R. M. H., Mason, T. R. & Ward, J. D. 1993 Flash-flood sediments and ichnofacies of the late Pleistocene Homeb silts, Kuiseb River, Namibia. *Sediment. Geol.* **85**, 579–599.
- Squirrell, H. C. & Downing, R. A. 1969 Geology of the South Wales coalfield. Part I. The country around Newport (Mon.), 3rd edn. *Mem. Geol. Surv. UK*.
- Strahan, A. 1896 On submerged land surfaces at Barry, Glamorgan. *Q. J. Geol. Soc. Lond.* **52**, 474–488.
- Stuart, A. J. 1982 *Pleistocene vertebrates in the British Isles*. London: Longman.
- Swinehart, J. B. 1990 Wind-blown deposits. In *An atlas of the Sand Hills* (ed. A. Bleed & C. Flowerday), pp. 43–56. Lincoln: Institute of Agriculture, University of Nebraska-Lincoln.
- Tapponnier, P., Peltzer, G., Le Dain, A. Y. & Armijo, R. 1982 Propagating extension tectonics in Asia: new insights from simple experiments with plasticine. *Geology* **10**, 611–616.
- Terzaghi, K. 1959 *Theoretical soil mechanics*. London: Chapman & Hall.
- Thulborn, R. A. 1990 *Dinosaur tracks*. London: Chapman & Hall.
- Tucker, M. E. & Burchette, T. P. 1977 Triassic dinosaur footprints from South Wales: their context and preservation. *Palaeogeogr. Palaeoclimatol. Palaeoecol.* **22**, 195–208.
- Vallois, H. V. 1931 Les empreintes des pieds humains des grottes préhistoriques du Midi de la France. *Palaeobiologica* **4**, 79–98.
- Van der Lingen, G. J. & Andrews, P. B. 1969 Hoof-print structures in beach sand. *J. Sedim. Petrol.* **39**, 350–357.
- Walker, M. & James, J. 1993 A radiocarbon dated pollen record from Vurlong Reen, near Caldicot, South Wales. In *Annual Report of the Severn Estuary Levels Research Committee for 1993* (ed. M. Bell), pp. 65–70, 119–125. Lampeter.
- Waters, R. A. & Lawrence, D. J. D. 1987 Geology of the South Wales Coalfield. Part III, the country around Cardiff, 3rd ed. *Mem. Geol. Surv. UK*.
- Welch, F. B. A. & Trotter, F. M. 1961 Geology of the country around Monmouth and Chepstow. *Mem. Geol. Surv. UK*.
- Whittaker, A. & Green, G. W. 1983 Geology of the country around Weston-super-Mare. *Mem. Geol. Surv. UK*.
- Whittle, A., Antoine, S., Gardiner, N., Milles, A. & Webster, P. 1989 Two late Bronze Age occupations and an Iron Age channel on the Gwent foreshore. *Bull. Board Celtic Stud.* **36**, 200–223.
- Williams, D. J. 1968 The buried channel and superficial deposits of the lower Usk and their correlation with similar features in the Lower Severn. *Proc. Geol. Ass.* **79**, 325–348.
- Wills, L. J. 1938 The Pleistocene development of the Severn from Bridgnorth to the sea. *Q. J. Geol. Soc. Lond.* **94**, 161–242.
- Withjack, M. O. & Scheiner, C. 1982 Fault patterns associated with domes—an experimental and analytical study. *Bull. Am. Ass. Petrol. Geol.* **66**, 302–316.
- Worssam, B. C., Ellison, R. A. & Moorlock, B. S. P. 1989 Geology of the country around Tewkesbury. *Mem. Geol. Surv. UK*.
- Yong, R. N. & Warkentin, B. P. 1975 *Soil properties and behaviour*. Amsterdam: Elsevier.

Received 11 July 1996; accepted 1 November 1996